

# OUMAN EH-800 Heating controller

## USER MANUAL

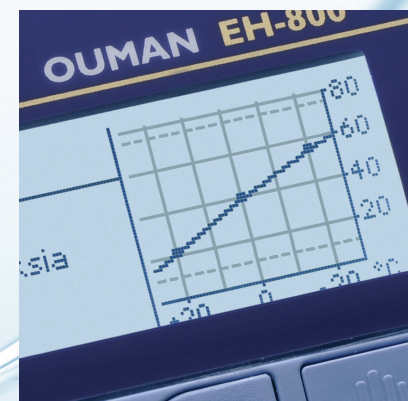
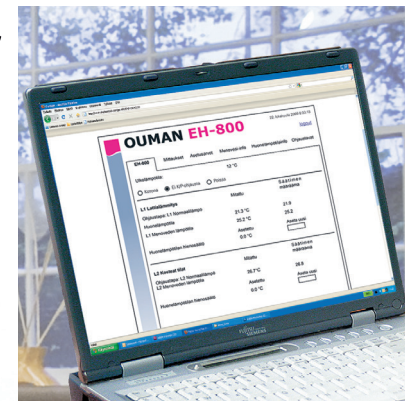
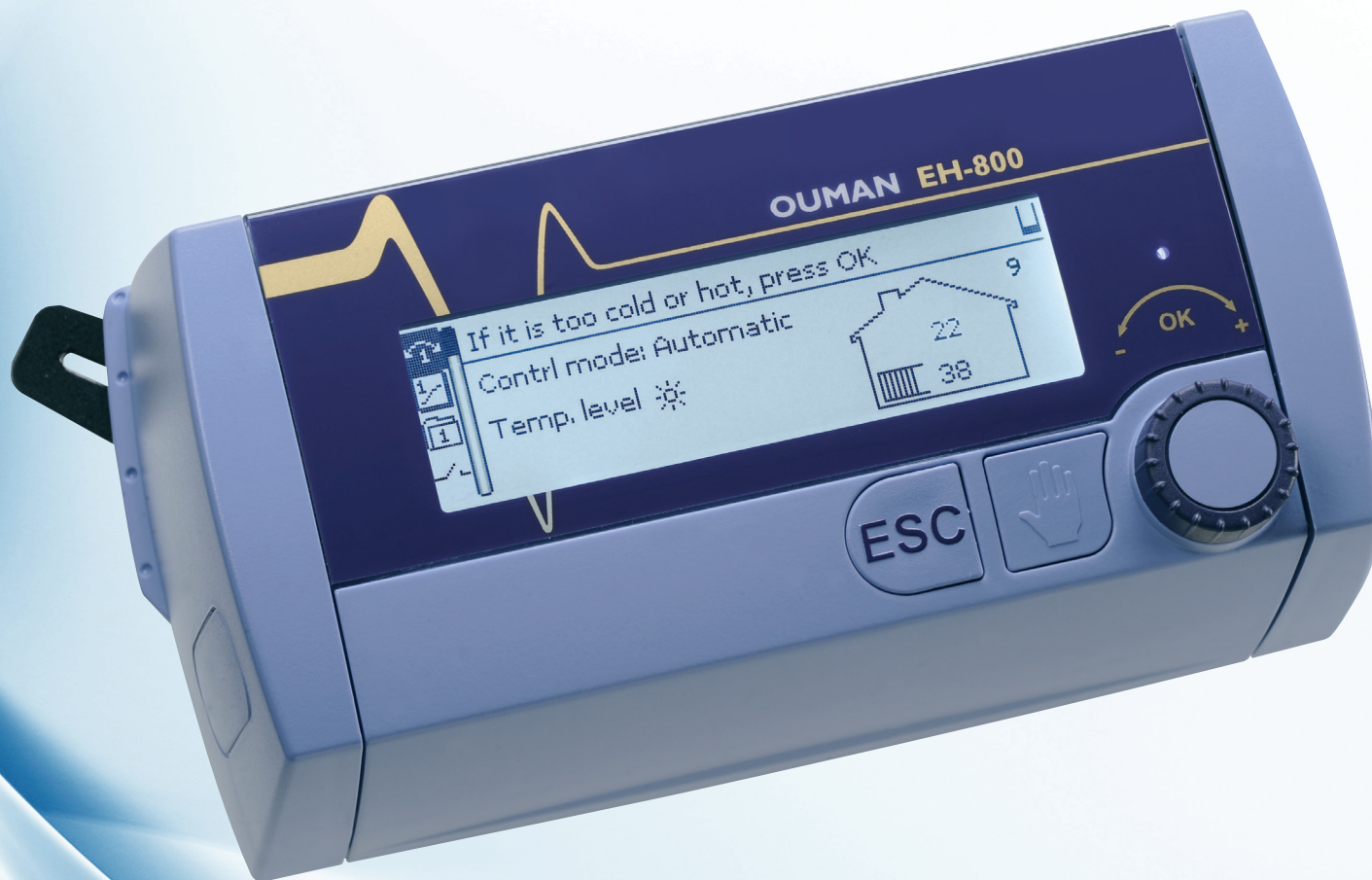

# OUMAN

OUMAN OY  
[www.ouman.fi](http://www.ouman.fi)

**EH-800 is a heating controller for private homes and business facilities having heating systems with circulating water. An extension unit can be obtained as optional equipment making it possible to take a second control circuit into use. If a second control circuit has been taken into use, numbers 1 or 2 will appear on the main display indicating which control circuit is in use. The EH-800 model has an intra/ internet connection (the EH-800 B model does not have it).**

**Control mode:**  
 Automatic  
 Forced control  
 Stand-by   
 Manual control

**Temperature level:**  
 Nominal temperature   
 Temperature drop   
 Big temperature drop   
 Pre-increase   
 Summer stop (see p. 16 "Summer function")

**Control command:** indicates what determines the temperature level  
 Time program   
 Home/away **H/A**

**Alarm indicator** = valve completely open  
**Valve control information** = valve completely closed  
 = valve opening  
 = valve closing

**Outdoor temperature**  
**Room temperature**  
**Temp. of water entering the heating circuit**

**Symbols for heating mode:**  
 = floor heating  
 = radiator heating









**Hand-operated lever**  
**Main menu symbols**  
**Cancel button**  
**Control knob (also the OK button)**  
**Hand-operated control knob**

**Turn the control knob to navigate in the menu and carry out increase and decrease commands.**

**Press the control button to enter the menu. Press the control knob (OK function) to confirm changes**

**Press for a number of seconds special settings that are seldom needed to appear on the display.**

# Table of contents

	<b>EH-800 automatically controls the temperature .....</b>	<b>4</b>			<b>Taking the H2 control circuit into use .....</b>	<b>35</b>	
	<b>Control of a second heating circuit .....</b>	<b>4</b>			H2 Process settings .....	35	
	<b>Fine adjustment .....</b>	<b>5</b>			Heating mode .....	35	
	<b>Heating curve settings .....</b>	<b>6</b>			Actuator selection .....	35	
	<b>Control circuit specific basic menu .....</b>	<b>7</b>			Actuator driving time.....	35	
	Measurements .....	7			Selecting the control circuit type .....	35	
	Graphic presentation of meas. history information.....	8			Changing the name of control circuit .....	35	
	Supply water info .....	9			Relay control .....	36	
	Room temperature info .....	11			Valve flushing .....	38	
	Settings .....	12			Text message settings .....	39	
	Control modes .....	14			EH-800 network settings .....	41	
	<b>Other controls .....</b>	<b>15</b>			Display settings .....	43	
	Home/Away control.....	15			Initiation of locking code .....	43	
	Relay control .....	16			Changing the locking code .....	44	
					Type information .....	44	
	<b>Clock functions .....</b>	<b>19</b>			<b>Communication via a mobile phone .....</b>	<b>45</b>	
	Temperature drop Weekly/24-hour program .....	19			 	<b>Special settings .....</b>	<b>47</b>
	Special calendar .....	20				<b>Product packages .....</b>	<b>52</b>
	Time and date .....	21				<b>Other optional equipment .....</b>	<b>53</b>
						<b>What to do if there is a fault .....</b>	<b>54</b>
	<b>Alarm notice .....</b>	<b>21</b>				<b>Index .....</b>	<b>55</b>
	<b>Alarms .....</b>	<b>22</b>				<b>Technical information .....</b>	<b>56</b>
	<b>Device settings .....</b>	<b>23</b>					
	Language/Kieli/Språk .....	23					
	Measurement channel settings .....	24					
	H1 Process settings.....	27					
	Heating mode .....	27					
	Direction of valve .....	29					
	Heating curve type .....	30					
	Control circuit name .....	31					
	Cascade control .....	32					
	Hybrid heating.....	33					

# EH-800 automatically controls the temperature

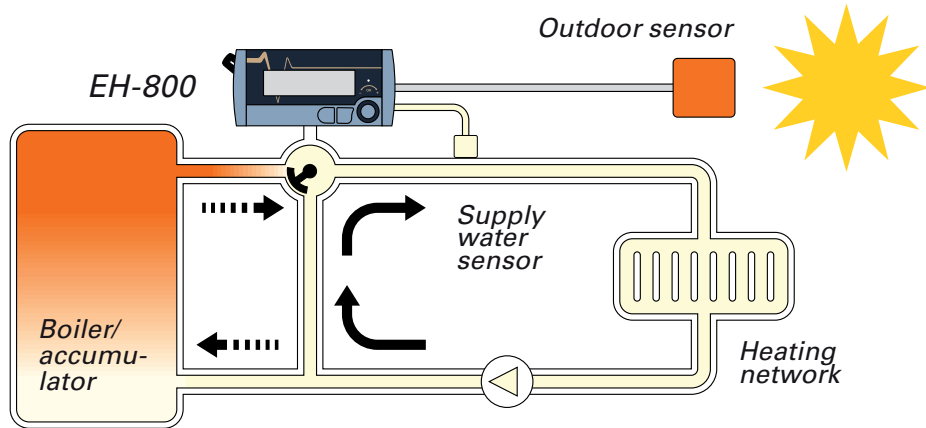

*EH-800 automatically controls the temperature of the water entering the heating network. The heating need changes according to the outdoor temperature.*

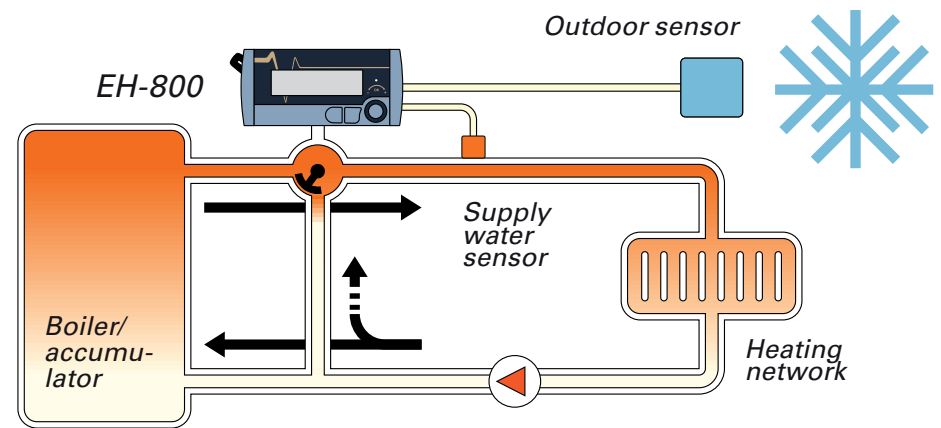

*As the outdoor temperature gets colder, the controller lets just enough heat into the network to keep the room temperature at an even level.*

## Control of a second heating circuit

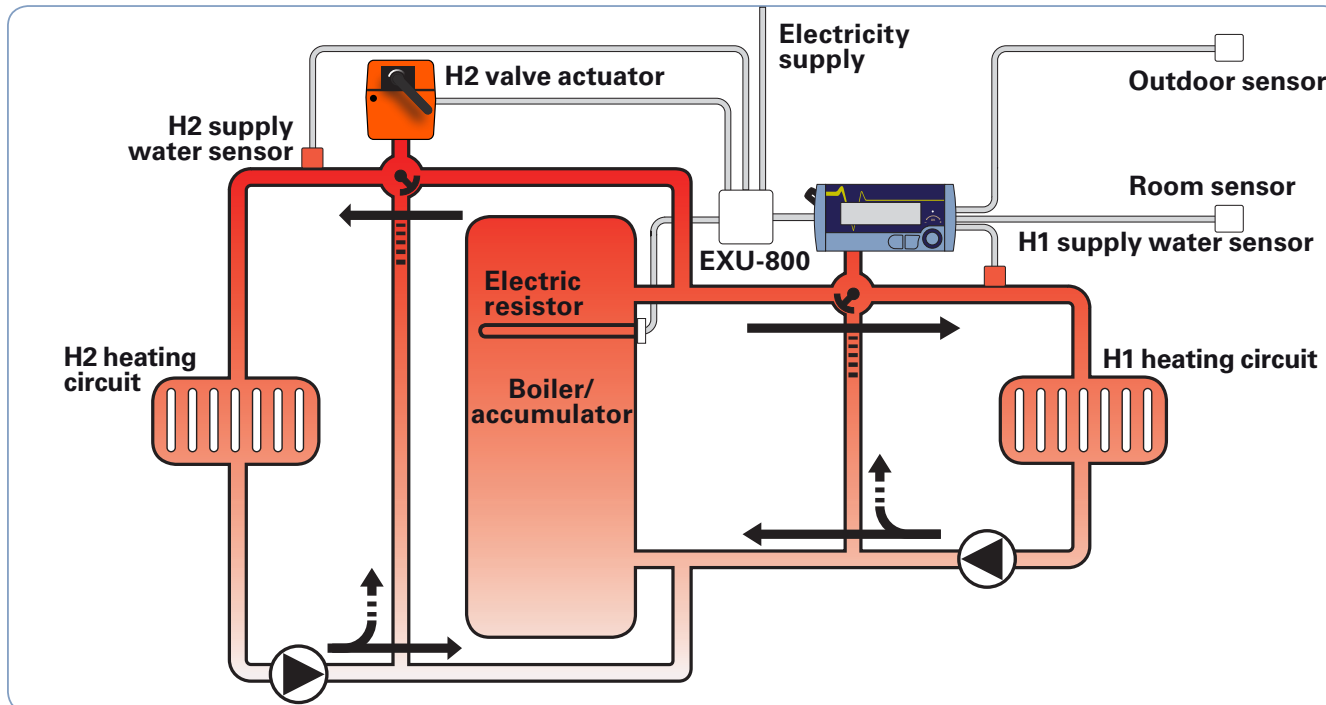

**An EXU-800 external unit can be connected to the controller making it possible to control a second heating circuit. As a result, e.g., heating of damp rooms can be controlled separately. For this to be possible, the facility's heating system must be divided into two circuits.**

*A basic diagram for connecting two heating circuits. The controller controls both heating circuits on the basis of the same outdoor temperature measurement but different supply water temperature measurements. Each heating circuit has its own curve and other settings that effect control.*

# Fine adjustment

The fine adjustment function enables you to make small changes in temperature. It pays to use this function when the room temperature remains the same but it is too cold or too hot.

## Room temperature measurement in use:

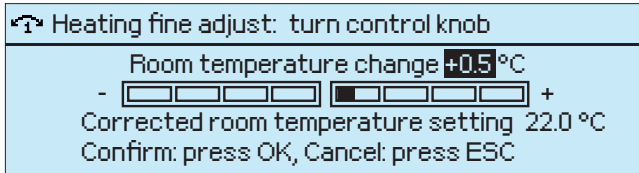



**When a room sensor is in use, fine tuning directly effects the calculated room temperature + 4°C.**

The corrected setting for the room temperature is "Room temperature setting + " Fine adjustment" + "Potentiometer (TMR/SP) determined room temperature setting change"

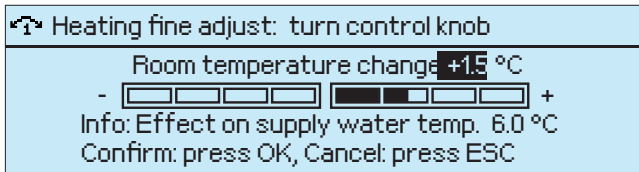
## Room temperature measurement is not in use:



**When the room sensor is not connected, fine adjustment effects the heating curve as a parallel shift and the steepness of the curve does not change. The effect of fine adjustment on the supply water temperature can be seen on the bottom row.**

-  effects the H1 control circuit.
-  effects the H2 control circuit.  
(only appears if the H2 control circuit has been taken into use, initiation see p. 35).

## Instructions:

Press OK in the main display.

Turn the control knob in the desired direction and press OK to confirm.

Fine adjustment settings can also be inspected and changed in settings (see p. 49).

If outdoor temperature changes effect the room temperature, the heating curve's settings must be changed. (see next page).

**Too cold**  
Use the fine adjustment to raise the room temperature.  
*In this example the room temperature is raised 0.5 °C.*

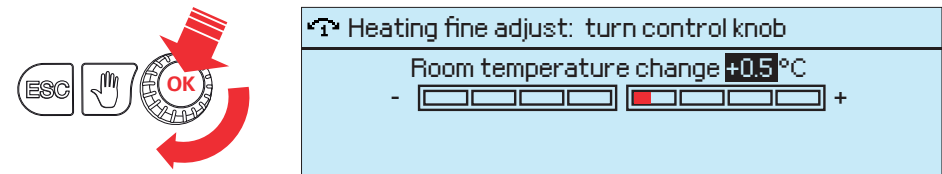

**Too hot**  
Use the fine adjustment to lower the room temperature.  
*In this example the room temperature is lowered 0.5 °C.*

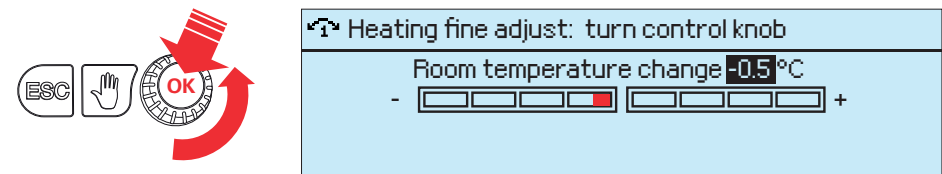

# Heating curve settings

The basis of an even room temperature is a heating curve of the correct shape. The correct shape depends on many factors. (the building's insulation, type of heat distribution, size of the network, etc.). The supply water temperature for different outdoor temperatures is set in heating curve settings. With Ouman EH-800 the heating curve can be adjusted exactly to meet the needs of the facility from either three or five points. A 3 point curve is the factory setting.

Examples of 3 point curve factory settings:

## 1. Floor heating, damp rooms

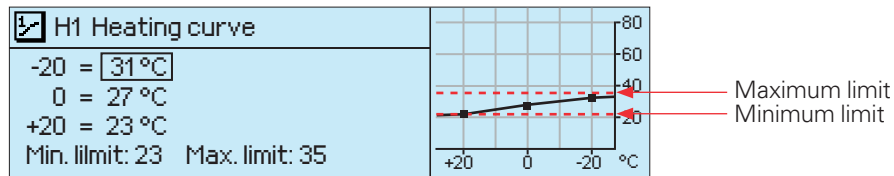

The supply water minimum limit setting also ensures a comfortable and good drying temperature in the summer.

## 2. Floor heating, normal heating curve

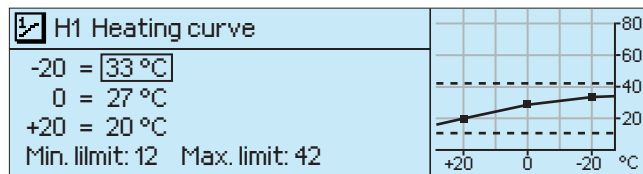

## 3. Radiator heating, normal heating curve

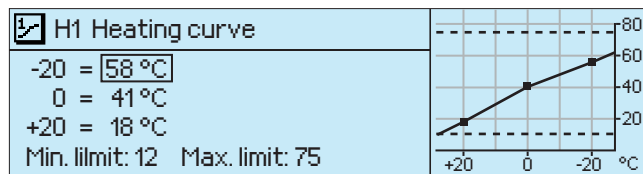

## 4. Radiator heating, steep heating curve

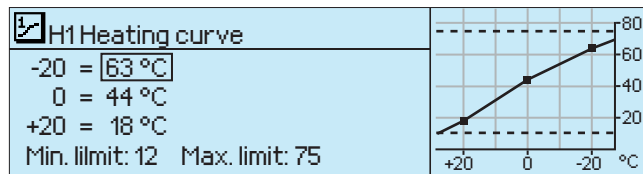

The controller has factory set curves and settings suitable for different heating modes that usually do not have to be changed.

The heating curve needs to be adjusted if the room temperature does not remain even when the temperature is below zero and falling.

If the room temp. drops, make the curve steeper (set the bigger values at -20 and 0).

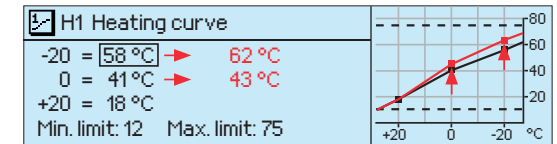

If the room temp. rises, make the curve less steep (set the smaller values at -20 and 0).

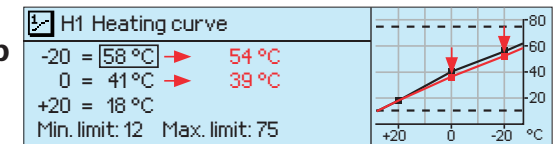

**Note! Changes effect room temperature slowly**

Wait at least 24 hours before readjusting settings. Especially in buildings having floor heating the delays in room temperature changes are quite long.

The 3-point curve has automatic curve adjustment! The controller does not allow descending curves or curves that are too concave.

A parallel shift can be made to the heating curve using the fine adjustment function (see p. 49) The 5 point curve is taken into use in process settings (see p. 30)

The ends of the heating curve are adjusted using the minimum and maximum limits. The supply water minimum limit setting ensures that the pipes do not freeze. The maximum limit setting ensures that excessively hot water that could damage structures (e.g., parquet with floor heating) does not enter the heating system.

 effects the H1 control circuit curve.

 effects the H2 control circuit curve. (only appears if the H2 control circuit has been taken into use, initiation see p. 35).

# 1 Basic menu: Measurements

## Basic menu -> Measurements

1 > Measurements	
H1 Supply water temperature	35.1 °C
Outdoor temperature	-18.2 °C
H1 Room temperature	21.5 °C
H2 Supply water temperature	32.5 °C

The measurements menu displays present information about connected sensors and valve positions. A factory set supply water sensor is connected to the controller. It has a separate plug-in for outdoor temperature. Information about measurement channels 3 and 4 on pages 23-25. Measurements 5 and 6 are also in use if an extension unit has been connected to the controller. Connect the supply water sensor of the second heating control circuit (H2) to the extension unit (EXU-800). When you take the H2 control circuit into use in process settings, automatically reserve measurement 5 of the EH-800 controller for H2 control water heating measurement.

Measurement	Range	Measurement information
<b>Supply water temperature</b>	0...+130°C	Present temperature of water entering the heating network.
<b>Outdoor temperature</b>	-50...+50°C	Present measured outdoor temperature.
<b>Room temperature</b>	-10...+80°C	Present room temperature.
<b>Return water temperature</b>	0...+130°C	Present temperature of water returning from the heating network.
<b>Measurement 3 (4, 5) (can be labelled)</b>	0...+130°C	Measurement channels 3, 4 and 5 can be used as free temperature measurements. If the measurement has not been labeled, it appears as "Measurement 3 (4)". Measurement channel 5 is in use if an extension unit is connected to the controller.
<b>Valve position</b>	0...100%	Present position of the valve.
<b>Cascade valve control</b>	0...100%	If cascade control is in use, the controller's display indicates into which position the controller is moving the valve at the present.
<b>Outdoor ave. temp (prev. day)</b>	-50...+50°C	The controller uses the average temperature of the previous day (24 hour period) e.g., when the outdoor sensor malfunctions.
<b>Delayed outdoor temp. measurement</b>		The average outdoor temperature that the controller uses for control. (setting the average p. 13).
<b>Delayed room temp. measurement</b>		The average room temperature that the controller uses for control (see p. 47).

Key word:  
**Measurements**



If a GSM is connected to the controller, you can read measurement information from a mobile phone. **Send a message: Measurements.** The controller sends the present measurement information to your mobile phone. (If you have a device ID, write the device ID in front of the key word, e.g., TC01 Measurements)

# 1 Graphic presentation of measurement history information

Basic menu -> Measurements -> Press OK at measurement information

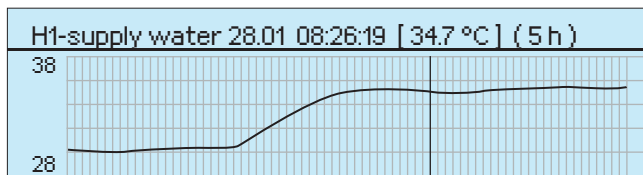

## Temperature measurement trend display:

Press OK at a temperature measurement, a trend display will appear for that measurement.

Use the control knob to browse measurement history. The exact measurement and time and date will appear at the top edge of the display next to the cursor. As a factory setting, temperatures are saved every ten minutes (=600 s). Press OK to alternately zoom in or zoom out the trend display. In case sampling interval is 10 minutes (600 s), the distance between the vertical lines is either 10 minutes or 1 hour. In this case, the controller's memory contains history information from the last 10 days. You may change trend sampling interval if you wish (Device settings -> Measurement channel settings, p. 25) Press ESC to exit the trend display.

Use the trend display to easily monitor, e.g., temperature drops and room temperature levels. You can also check outdoor temperatures from the trend.

**The controller automatically flushes and calibrates the valve once a week on (as a factory setting Monday at 08 am). The controller first completely closes the valve and then if the flush function has been taken into use it opens it to the flush position and then to the position determined by the controller (see Device settings > Valve flushing, p. 38)**

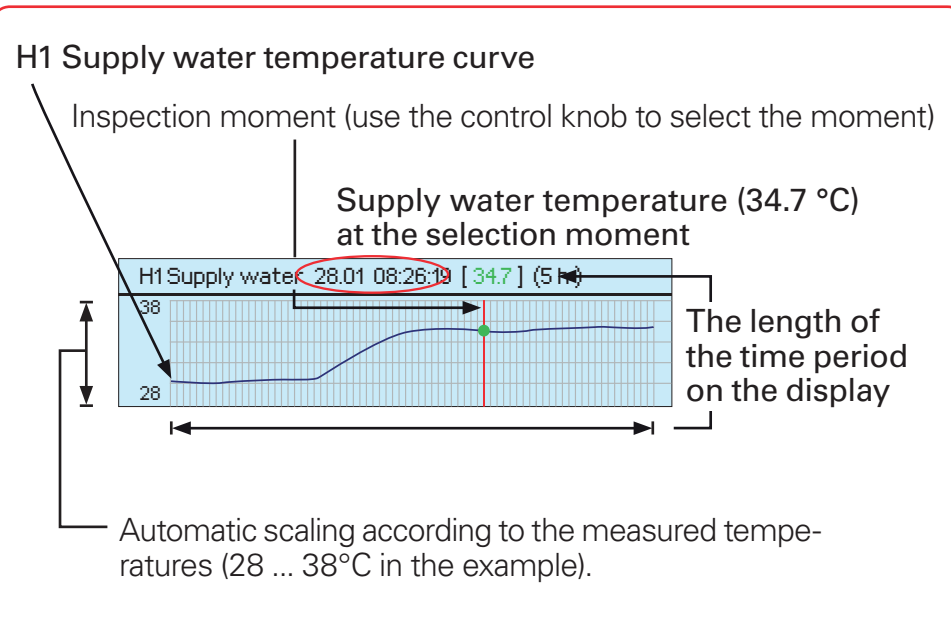

You may download a trend file from EH-800 device to your pc via controller web page and examine the trend chart on your pc display. You may use Ouman Trend software to look at a trend file as a chart. Go to [www.ouman.fi](http://www.ouman.fi) to download the software.



# 1 Basic menu: Supply water info

## Basic menu -> H1 (H2) Supply water info

1 >H1 Radiator heating...H1 Supply water info	
Supply water according to curve	35.1 °C
Effect of fine adjustment	5.9 °C
-----	
Calculated supply water setting	41.0 °C

The supply water info shows which factors are effecting the supply water temperature at the time of inspection. The starting point is the supply water temperature according to the outdoor temperature (according to the heating curve). For example, if you see a temperature drop in the supply water info you can determine which settings may be incorrect (e.g., minimum or maximum limit settings).

*According to the example in the diagram the supply water is 35.1°C. The supply water setting has been adjusted 5,9 °C.using the fine adjustment. According to these the calculated supply water setting is 41.0°C (=35.1 + 5.9).*

Factors effecting the supply water temp.	Explanation
Supply water according to curve	Supply water temperature according to the curve at the present outdoor temperature.
Effect of floor heating anticipate	Effect of the floor heating anticipate function on the supply water temperature (see p. 13).
Effect of outdoor temp. delay	The delaying effect of the outdoor temperature measurement on supply water control calculated from the monitoring time period (see p 13).
Effect of fine adjustment	Effect of fine adjustment on the supply water temperature
Effect of room compensation	Effect of room compensation on the supply water
Room compensation time adjustment	Additional fine adjustment to room compensation based on present control (effect of I control) <i>Hint: If the room compensation's time adjustment always adjusts the room temperature in the same direction, e.g., +3°C when the outdoor temperature is below zero, it means that the curve has been set too low. In this example, the supply water curve must be raised at -20°C outdoor temperature.</i>
Time program effect on supply water	Effect on the supply water temperature of a temperature drop or big temperature drop by the week clock control or exception calendar control.
Home/Away control by switch Home/Away control by SMS Home/Away control by controller	Effect of "Away" control on the supply water temperature. The switch, SMS, or control row indicates where the home or away command has come from. For example, Home/Away SMS, mobile phone control.
Effect of autumn drying	Effect of automatic autumn drying on the supply water temperature (se p. 51).

# Supply water info

Factors effecting the supply water temp.	Explanation
Effect of maximum limit	Supply water temperature drop due to the maximum limit.
Effect of minimum limit	Supply water temperature increase due to the minimum limit. Both the general minimum limit set for the supply water and $-20^{\circ}\text{C}$ outdoor temperature effect the minimum limit.
Effect of return water compensation	Effect of the return water limiting functions on the supply water. If the return water temperature drops below the lower limit the supply water temperature is raised and if the return water temperature rises above the maximum limit the supply water temperature is lowered. The return water temperature measurement can be taken into use only in the H1 control circuit.
Stand-by	Lowering effect of free temperature drop on supply water temperature
H1 Summer function	The controller closes the valve in summer function (see p. 13).
Outdoor temp. limits the drop	The effect of the temperature drop block on the supply water temperature (see p. 48)
Calculated supply water setting	Present supply water temperature determined by the controller. All the factors are considered that affect the supply water temperature.
Effect of setting delay	Effect of the limit set for the speed of change of the supply water setting on the supply water temperature. (see p. 51).
Supply water temperature	Present measured supply water temperature.

**The controller controls the supply water temperature to its calculated setting.**

Key words:  
**H1 Supply water info**  
**H2 Supply water info**



Send a message: **H1 Supply water info.**

The controller sends a supply water info from the H1 heating circuit to your mobile phone that shows you the controller determined supply water temperature at the present and the factors effecting supply water control. The message cannot be changed or sent back to the controller.

# 1 Basic menu: Room temperature info

Basic menu -> H1 (H2) Room temperature info

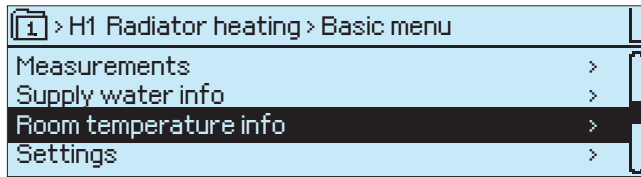

If a room sensor is connected to the controller, you can check the room temperature info to see which factors determine the room temperature at the time of inspection.

Factor effecting the room temperature	Explanation
Delayed room temp. measurement	Delayed room temperature that the controller uses in control (see p. 47).
Room temperature setting	Room temperature setting set by the user.
Effect of fine adjustment	Effect of fine adjustment on the room temperature setting (see p. 5 and 49).
Effect of potentiometer	Room temperature setting change by the potentiometer (only in H1).
Time program effect on room temp.	Room temperature drop by week clock or exception calendar.
Home/Away control by switch Home/Away control by SMS Home/Away control by controller	Room temperature change controlled by the Home/Away switch. Effect of a "Home" or "Away" command by a mobile phone on the room temperature. Effect of a "Home" or "Away" control by the controller on the room temperature
Effect of autumn drying	Effect of automatic autumn drying on room temperature.

Calculated room setting =

1 >H1 Radiator heating...Room temperatur info	
Room temperatur setting	21.0 °C
Effect of fine adjustment	0.5 °C
-----	
Calculated room setting	21.5 °C

Present room temperature setting determined by the controller.

Example.

The room temperature has been set at 21.0°C.

Fine adjustment raises the temperature 0.5°C.

The controller sets the calculated room temperature at 21.5°C (=21.0+ 0.5).

Key words:

H1 Room temperature info  
H2 Room temperature info



**Send a message: H1 Room temperature info.** The controller sends a room temperature info from the H1 heating control circuit to your mobile phone that shows you the calculated room temperature setting that can be used in control. The message can't be changed or sent back to the controller.

# 1 Basic menu: Settings

## Basic menu -> H1 (H2) Settings

1 > H1 Radiator heating > Settings	
Room temperature	21.0 °C >
Temperature drop( room temperature )	1.5 °C >
Big temperature drop ( room temp )	5.0 °C >
Supply water min limit	12.0 °C >

1 Room temperature	
<b>21.0°C</b>	
min: 0.0 max: 95.0	

The EH-800 controller's settings are divided into two groups; main settings and less frequently adjusted special settings which can be seen by pressing OK for a number of seconds. These settings are set into the settings menu. Press OK again for a number of seconds to hide the settings.

**Changing a setting:** Turn the control knob until the setting to be changed appears against a black background. Press OK to open a new window in which the changes are made. Press Esc to exit..

**Locking settings:** Lock the settings to prevent unauthorized persons from changing settings. The controller will then ask for the locking code before it lets you change settings. (see p. 43).

This section illustrates main settings. Special settings are illustrated on pages 47-51.

Setting:	Factory-setting	Range:	Information about settings:
<b>Supply water setting</b>	15.0°C	0.0...95.0°C	Can be set when the heating mode is the constant temperature controller.
<b>Room temperature</b>	21.0°C	5.0...50.0°C (0.0...95.0°C)	Basic room temperature setting for the controller set by the user. The room temperature can be set when room temperature measurement has been taken into use. The room temperature setting range can be increased or limited between 0.0...95.0 °C (see room temperature setting range min/max, p. 48 in special maintenance settings).
<b>Temperature drop</b>			Amount of temperature drop set by the user. (factory setting; 6 °C with radiator heating, 2 °C with floor heating).
Supply water (radiator h.)	6°C	0...90°C	If room temperature measurement has been taken into use, the temperature drop is given directly as a room temperature drop.
Supply water (floor h.)	2°C	0...90°C	
Room temperature	1.5°C	0...90.0°C	
<b>Big temperature drop</b>			A big temperature drop set by the user (factory setting; 16 °C with radiator heating, 6 °C with floor heating). If room temperature measurement has been taken into use, the big temperature drop is given directly as a room temperature drop.
Supply water (radiator h.)	16°C	0...90°C	
Supply water (floor h.)	6°C	0...90°C	
Room temperature	5.0°C	0...90.0°C	

**Temperature drops can be activated by the controller's time program, home-away function or the controller's forced control.**

# 1 Settings

Note! Some of the settings (special settings) are hidden. Press OK for a number of seconds to alternately make them appear or disappear.

Setting	Factory-setting	Range	Information about settings
<b>Supply water minimum limit</b>		5.0...95.0°C	Minimum allowed supply water temperature. A higher minimum temperature is used in damp rooms and tiled rooms than in, e.g., rooms having a parquet floor to ensure a comfortable temperature and removal of moisture in the summer.
radiator heating	12.0°C		
floor heating normal	12.0°C		
floor heating damp rooms	23.0°C		
constant temp. controller	12.0°C	0.0...95.0°C	
<b>Supply water maximum limit</b>		5...95°C	Maximum allowed supply water temperature. The maximum limit prevents the temperature in the heating circuit from rising too high, preventing damage to pipes and surface materials. If, e.g., the characteristic heating curve setting is incorrect, the maximum limit prevents excessively hot water from entering the network.
radiator heating	75°C		
floor heating normal	42°C		
floor heating damp rooms	35°C		
<b>Outdoor temp. measurement delay</b>			The length of the outdoor temperature measurement monitoring period from which the controller calculates an approximate average. Supply water temperature control occurs on the basis of the measurement of the average. The factory setting for the radiator heating delay is 2 hours and in floor heating (0h) the delay is not used. If the temperature is below zero and falling and for a period of time the room temperature rises too high or if the weather warms up and for a period of time the room temperature falls too low, increase the outdoor temperature delay time. If the opposite happens, decrease the delay time.
radiator heating	2h	0...15h	
floor heating	0h	0...5h	
<b>Summer function (outd. t. limit)</b>	Not in use	Not in use ...5...95°C	The outdoor temp. limit at which the H1 control valve is closed. (pump stop see p. 16). The setting is the same for control circuits H1 and H2. The summer function is inactivated when the outdoor temp. is at least 0,5° C below the setting and the clearance delay has ended (clearance delay see p. 50) If floor heating for damp rooms is in use, the factory setting for the summer function is "not in use". The summer function is inactivated if the supply water freezing risk gives an alarm. This setting can be set in the H2 control circuit only if "closed" has been selected for the valve position in summer function (see p. 50)
<b>Floor heating anticipate</b>			Floor heating anticipate attempts to minimize changes in room temp. when the outdoor temp. changes. In floor heating, the concrete slows the transfer of heat into the room. Floor heating anticipate minimizes changes in room temp. when the outdoor temp. changes. If the temp. is below zero and falling and for a period of time the room temp. falls too low or if the weather warms up and for a period of time the room temp. rises too high, increase the outdoor temp. delay time. If the opposite happens, decrease the delay time.
radiator heating	-	-	
floor heating	2h	0...6h	

Key words:  
**H1 Settings**  
**H2 Settings**



**Send a message:** Settings. (If you have a device ID, write the device ID in front of the key word, e.g., TC01 Settings). The controller sends the present settings to your mobile phone. If you want to change settings, write the new setting in place of the old setting and send a message back to the controller. The controller sends the setting as a return message. You can check the message to see that the setting has been changed.

# 1 Basic menu: Control modes

## Basic menu -> H1 (H2) Control modes

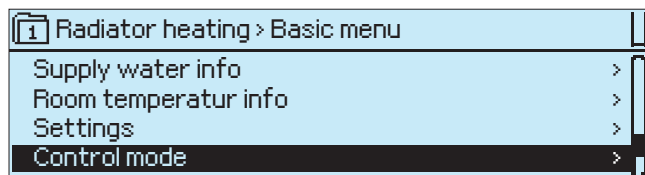

The selected control mode always appears in the controller's basic display.

**Changing the control mode:** Turn the control knob to move to control mode in the basic display. The selected control mode appears in the display. Press OK to open a new window. Turn the control knob and press OK to select the desired control mode. Press ESC to exit.

### Control mode

### Explanation

#### Automatic

EH-800 controls the supply water temperature automatically according to the need for heating and possible time programs and home-away control commands. Automatic control is the recommended control mode.

**Forced control, nominal temp.**  
**Forced control, temp. drop**  
**Forced control, bigger temp. drop**

Continuous nominal temperature.  
 Continuous temperature drop  
 Continuous big temperature drop

} **None of the time programs are in effect with forced drive.**

#### Manual electrical

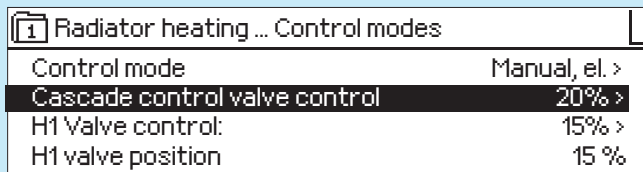

The valve remains in that position until manual control has been turned off. The measured H1 valve position appears in the controller's display. If cascade control is in use, the controller can move the H1 valve into the desired position using the actuator connected to EH-800. The controller can also move the cascade control valve into the desired position. If cascade control is in use and you switch the controller to manual via a mobile phone, the % that you give represents the combined positions of the valves. *Examples: 100% = both valves completely open. 50% = the valve connected to EH-800 is closed and the cascade control valve is completely open. 30% = the valve connected to EH-800 is closed and the cascade control valve is 60% open.*

#### Stand-by

The controller lets the supply water temperature drop freely to the freezing limit.

**Valve flushing and valve calibration run is once a week** (see p. 38).

#### Manual mechanical

Unplug the controller from the power source. The EH-800 controller also has a mechanical hand-operated lever. Press the control knob (1) and turn the lever (2) simultaneously. The position of the hand-operated lever indicates the position of the valve.



Key words:  
**H1 Control modes**  
**H2 Control modes**



Send a message: **H1 Control modes**. The controller sends a return message in which a \* appears in front of the control mode in use. If you want to change the control mode, **move the \*** in front of the desired control mode and send the message back to the controller. The controller will then send a return message showing that it has switched to the desired control mode.

# Home/Away control (H/A)

Muut ohjaukset -> Home/Away control

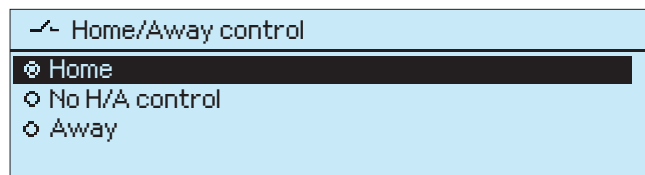

The "Home" and "Away" controls can only be used if the controller is on automatic control. The control command can be given from the controller's menu, from the home/away switch connected to the controller or from a mobile phone. Regardless of from where the control command comes, the controller's Home/Away display is updated. The last control command is in use. The control command affects both H1 and H2 control circuits. If only the second control circuit is to be used in the home / away control, set the second control circuit temperatur setting value to zero (see page 12).

Home/Away control	Explanation
Home	When a home control command is received, the controller by-passes the present temperature drop command in use and switches to <u>nominal temperature</u> .
Away	An away control command causes the controller to switch to <u>temperature drop</u> . The controller switches to a big temperature drop if the week program or exception calendar controls it to a big temperature drop.
No H/A control	In the no Home/Away control mode the controller is on automatic control and follows the week program and exception calendar. If time programs have not been made, the controller is in the nominal temperature mode.

**Example 1. The controller does not have a week program or exception calendar program:**

An "Away" command causes the controller to switch to a temperature drop.

A "Home" command causes the controller to switch back to a nominal temperature mode.

**Example 2. The controller has a week program:**

An "Away" command causes the controller to switch from the weekly program to a temperature drop.

A "Home" command causes the controller to switch to a nominal temperature mode and then begin temperature drops according to the weekly calendar.

**Example 3. The temperature drop has been made with the exception calendar and you want to temporarily switch to a nominal temperature.**

A "Home" control causes the controller to switch to the nominal temperature mode.

An "Away" control command causes the controller to switch back to a temperature level controlled by the exception calendar.

Key words:

Home

Away



**The Home/Away control is only in effect if the controller is on automatic control.**

**When you send a Home or Away message, the controller sends back an OUMAN message showing that the HOME or AWAY control is on.**

# Other controls: Relay control

## Other controls -> Relay control

↖ >Other controls	
Home/Away control	No H/A control >
Relay control	>

Relay control is in use if an extension unit is connected to the controller. Relay control is taken into use from the controller's device settings. Relay control can be used to stop the pump for the summer. or the relay can be controlled according to the temperature, temperature difference, position of the valve or the time program. If hybrid heating has been taken into use, the controller reserves the relay for charge pump control. Normally, the relay's control mode is automatic. If necessary, the relay can be force controlled ON or OFF.

### Relay use

### Explanation

#### Pump summer stop:

↖ > Other controls > Relay control	
Relay control	Pump summer stop
Control mode	Automatic>
Summer function (outdoor temp. limit)	17°C>
Pump state	Run

The controller stops the pump when the outdoor temperature rises above the "Summer function (outdoor temp. limit)" (see p. 13). Go to H2 control circuit special settings to select whether the H2 control circuit is to be actively controlled during pump summer stop or whether the H2 control circuit valve is to be at the minimum limit (see p.50). During the period when the pump is stopped it runs once a week during valve flushing to prevent the valve from becoming stuck (see p. 38). The pump runs when the controller is without operating voltage (230V). If "ON" has been selected, the pump runs continuously and the relay is open. If "OFF" has been selected the pump is stopped. If "Auto" has been selected, pump runs according to the outdoor temperature.

#### Relay control according to the temperature:

↖ > Other controls > Relay control	
Relay control	According to the temperature
Control mode	Automatic>
Setting at which the relay is active (ON)	58°C >
Hysteresis	4°C >
Temperatur of boiler	67 °C
Relay control mode	ON

The controller's device settings determines which temperature measurement controls the relay and whether relay control begins when the temperature rises or falls to that setting. The controller's display shows you which temperature measurement information relay control uses, the temperature measurement information and the present state of the relay. Examples:

1. When the boiler temperature rises above the setting the controller switches on the charging pump and collects heat into the accumulator. When the boiler temperature drops below the setting the amount of the hysteresis, the charging pump is switched off.
2. The controller switches on an additional heat source (e.g., an electric heater), when the temperature of the boiler drops below the setting and switches off the electric heater when the temperature of the accumulator rises the amount of the hysteresis above the setting.



# Relay control

Other controls -> Relay control

## Relay use

## Explanation

### Relay control according to the temperature difference:

☑ > Other controls > Relay control	
Relay control	Accord. to the temp. difference
Control mode	Automatic >
Temp. of solar collector (A)	68.3°C >
Temperatur of accumulator (B)	55.4°C >
Temp. diff. (A-B) where relay is active	10 °C >
Temp.diff. (A-B) where relay is released	3 °C >
Relay control mode	ON

Two different temperatures are compared, e.g., the temperatures of the solar collector and accumulator. When the temperature difference is large enough, e.g., 10 °C, the solar collector's circulating pump is switched on. When the temperature difference drops to, e.g., 3 °C, the circulating pump is switched off.

### Relay control according to the H1 Valve position:

☑ > Other controls > Relay control	
Relay control	Accord. to H1 valve position
Control mode	Automatic >
Valve position where relay is active	95% >
Valve position where relay is released	90% >
H1 Valve position	85%
Relay control mode	OFF

Relay control is switched on (ON) when the valve opens to the set setting. Relay control is switched off when the valve position is at the OFF setting. The present actuator position and relay mode can be seen from the controller's display.

Select the energy mode according to H1 control valve's control information.

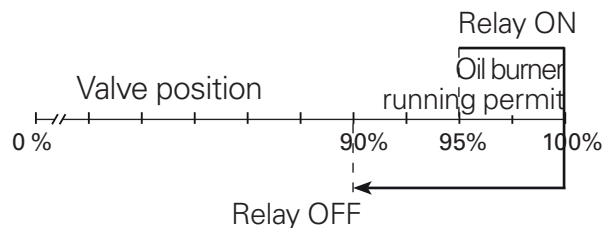

Example: The water in the boiler is first warmed using inexpensive energy (e.g., air-to-water heat pump) When EH-800 has almost completely opened the control valve (e.g., 95%) the relay is activated (ON) and the oil burner receives a running permit. When the heating need decreases the controller starts closing the valve. The oil burner's running permit is inactivated when the valve has closed to the point at which the relay switches to the OFF mode (e.g., 90%).

### General alarm:

☑ Other controls > Relay control	
Relay control	General alarm
Relay control mode	OFF

When any of the alarms is activated in the device, also the sum/common alarm is activated. The common alarm does not indicate, which alarm in the device is active. When any of the alarms is unacknowledged, the relay is active.

An example: If EH-800 is installed in a separated room, the information of the controller's alarm can be transmitted to the accommodation by connecting e.g. an indicator lamp or a siren to the relay. When the controller alarms, the indicator lamp or the siren indicates the alarm.

## Relay use

## Explanation

### Relay control according to the time program:

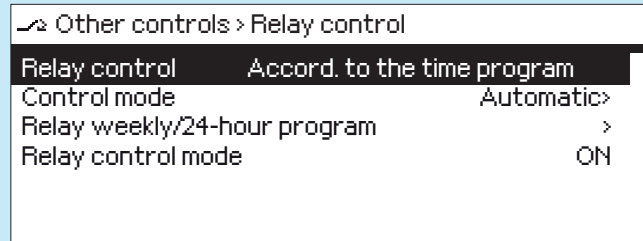

Other controls > Relay control	
Relay control	Accord. to the time program
Control mode	Automatic>
Relay weekly/24-hour program	>
Relay control mode	ON

The relay changes its mode according to its week/24 hour program. The controller's display shows the present control mode. The relay's week/24 hour program can also be found under clock programs. Set the time for relay control. Select the mode for the relay at the set time. Then select the days of the week that relay control is to be used.

Example: The floor is heated using night time electricity.

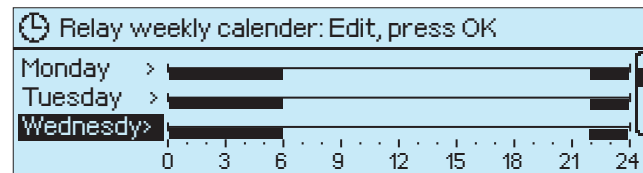

Relay weekly calendar: Edit, press OK	
Monday >	[Bar chart showing relay ON from 22:00 to 06:00]
Tuesday >	[Bar chart showing relay ON from 22:00 to 06:00]
Wednesday>	[Bar chart showing relay ON from 22:00 to 06:00]

### Creating the week/24 hour program for the relay:

Press OK at the "Add new" row.

Press OK. Set the time for relay control (set the hours and minutes separately) and Press OK to confirm the time.

Press OK, then turn the control knob to set the mode for the relay and press OK to confirm. Press OK at each day of the week that the control command is to be set for. Press OK at the end of the row to confirm the new time program. Press ESC to exit.

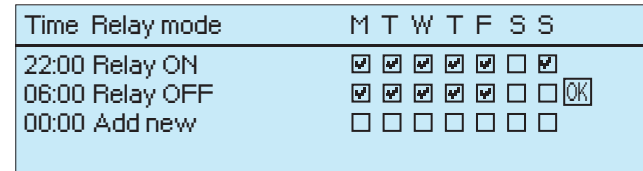

Time	Relay mode	M	T	W	T	F	S	S
22:00	Relay ON	<input checked="" type="checkbox"/>	<input checked="" type="checkbox"/>	<input checked="" type="checkbox"/>	<input checked="" type="checkbox"/>	<input checked="" type="checkbox"/>	<input type="checkbox"/>	<input checked="" type="checkbox"/>
06:00	Relay OFF	<input checked="" type="checkbox"/>	<input checked="" type="checkbox"/>	<input checked="" type="checkbox"/>	<input checked="" type="checkbox"/>	<input checked="" type="checkbox"/>	<input type="checkbox"/>	<input checked="" type="checkbox"/>
00:00	Add new	<input type="checkbox"/>	<input type="checkbox"/>	<input type="checkbox"/>	<input type="checkbox"/>	<input type="checkbox"/>	<input type="checkbox"/>	<input type="checkbox"/>

In the example, relay control is activated Sunday - Friday from ten p.m. to six a.m.

### In hybrid heating, the relay is used to control the charge pump:

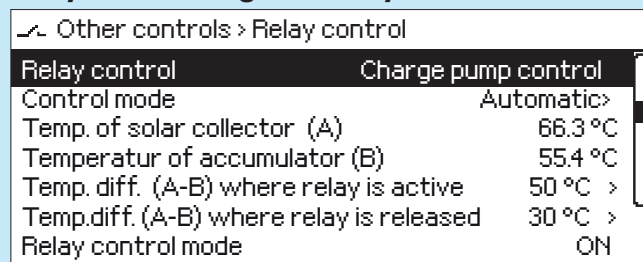

Other controls > Relay control	
Relay control	Charge pump control
Control mode	Automatic>
Temp. of solar collector (A)	66.3 °C
Temperatur of accumulator (B)	55.4 °C
Temp. diff. (A-B) where relay is active	50 °C >
Temp.diff. (A-B) where relay is released	30 °C >
Relay control mode	ON

Two temperatures are compared, e.g. solar collector temperature and accumulator temperature. When the temperature difference grows big enough (e.g. 10°C), the solar collector charge pump starts. When the temperature difference gets small enough (e.g. 2 °C), the pump stops.

Key word:  
**Relay control**



Send a message: **Relay control**. The controller sends a return message with a \* in front of the control mode in use (auto/ON/OFF). If you want to change the control mode, move the \* in front of the desired control mode and send a message back to the controller. The controller sends a return message showing that the controller has changed the control mode.

# Temperature drop Weekly/24-hour program

Clock functions -> H1 (H2) Weekly/24-hour program

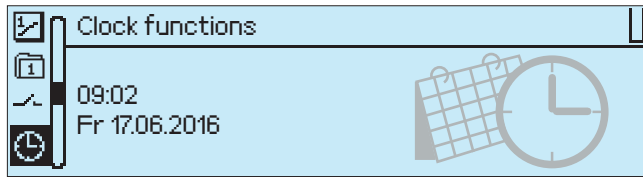

The week program is used to make temperature drops occurring at regular intervals. The week program can be seen from the graph or the edit display. The bars on the graph indicate when the temperature drop is active and the switch times appear at the bottom.

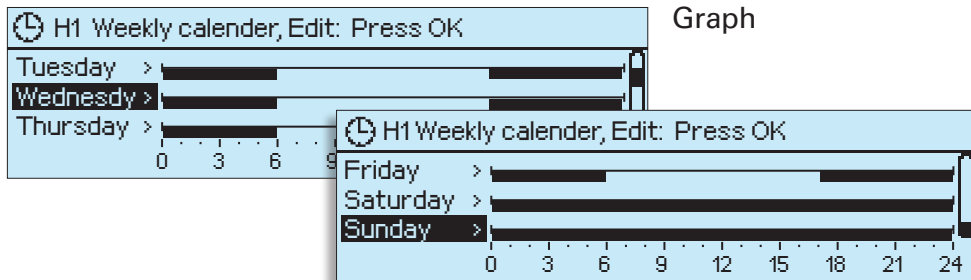

## Browsing the week program:

Turn the control knob to browse the week program. If you want to see exact switch times or you want to change, delete or add switch times, press OK at some day of the week.

Time	Temp. level		M	T	W	T	F	S	S
06:00	Nominal temp.		<input checked="" type="checkbox"/>	<input checked="" type="checkbox"/>	<input checked="" type="checkbox"/>	<input checked="" type="checkbox"/>	<input checked="" type="checkbox"/>	<input type="checkbox"/>	<input type="checkbox"/>
17:00	Temperat. drop		<input checked="" type="checkbox"/>	<input checked="" type="checkbox"/>	<input checked="" type="checkbox"/>	<input checked="" type="checkbox"/>	<input checked="" type="checkbox"/>	<input type="checkbox"/>	<input type="checkbox"/>
00:00	Add new		<input type="checkbox"/>	<input type="checkbox"/>	<input type="checkbox"/>	<input type="checkbox"/>	<input type="checkbox"/>	<input type="checkbox"/>	<input type="checkbox"/>

An edit display

An edit display will open up which displays all the switch times and also the heating mode and days of the week of the switch times.

The example shows a week program for an office with a temperature drop Monday – Friday from 5 pm to 6 am.

## Adding a new switch time:

Press OK at the “Add new” row.

Press OK. Set the switch time (set hours and minutes separately) and press OK.

Press OK and then turn the control knob to set the temperature level and press OK. Press OK at each week day to set the days of the week. Press OK at the end of the row to confirm the new time program. Exit with ESC.

## Editing the week program:

1. Set the switch time
2. Set the desired temperature
3. Select the day of the week

Time	Temp. level		M	T	W	T	F	S	S
06:00	Nominal temp.		<input checked="" type="checkbox"/>	<input checked="" type="checkbox"/>	<input checked="" type="checkbox"/>	<input checked="" type="checkbox"/>	<input checked="" type="checkbox"/>	<input type="checkbox"/>	<input type="checkbox"/>
17:00	Temperat. drop		<input checked="" type="checkbox"/>	<input checked="" type="checkbox"/>	<input checked="" type="checkbox"/>	<input checked="" type="checkbox"/>	<input checked="" type="checkbox"/>	<input type="checkbox"/>	<input type="checkbox"/>
00:00	Add new		<input type="checkbox"/>	<input type="checkbox"/>	<input type="checkbox"/>	<input type="checkbox"/>	<input type="checkbox"/>	<input type="checkbox"/>	<input type="checkbox"/>

Turn the control knob to move the frame to the value you want to change and press OK. The value to be changed will have a black background. Press OK. Made the change and press OK. Exit with ESC.

## Deleting a switch time:

Time	Temp. level		M	T	W	T	F	S	S
06:00	Nominal temp.		<input checked="" type="checkbox"/>	<input checked="" type="checkbox"/>	<input checked="" type="checkbox"/>	<input checked="" type="checkbox"/>	<input type="checkbox"/>	<input type="checkbox"/>	<input type="checkbox"/>
17:00	Delete switch time		<input checked="" type="checkbox"/>	<input checked="" type="checkbox"/>	<input checked="" type="checkbox"/>	<input checked="" type="checkbox"/>	<input type="checkbox"/>	<input type="checkbox"/>	<input type="checkbox"/>
00:00	Add new		<input type="checkbox"/>	<input type="checkbox"/>	<input type="checkbox"/>	<input type="checkbox"/>	<input type="checkbox"/>	<input type="checkbox"/>	<input type="checkbox"/>

Turn the control knob to the switch time you want to delete and press OK. Press OK at temperature level and select “Delete switch time” and press OK at the end of the row.

# Special calendar

Clock functions -> H1 (H2) Special calendar

 Clock functions	
H1 Weekly/24-hour program	>
H2 Weekly/24-hour program	>
<b>H1 Special calendar</b>	>
H2 Special calendar	>

Temperature drops lasting over a week or temperature drops that differ from the normal week program are done with the special calendar. The special calendar is stronger than the week calendar.

It is easy to make a temperature drop with the special calendar, e.g., when going on a vacation for a longer period of time. If the controller's pre-increase function has been taken into use, set the time you are returning home as the end time. Select "Automatic" at the ending time. The pre-increase ensures that a nominal temperature will be reached at the ending time (see p. 48).

 The control command symbol that appears in the EH-800 controller's basic display automatically changes according to what is controlling heating levels. When the control command comes from the set time program (week/24 hour clock or special calendar), a symbol of a clock appears in the main display.

*In this example, there is a big temperature drop from 21.12.2015 to 03.01.2016 and then the controller switches to a nominal temperature mode if the week program or Home /Away control doesn't control the temperature drop.*

Day	Time	Special calendar mode	
21.12.2015	08:00	Big temp. drop	
03.01.2016	16:00	Automat	>
00.00.0000	00:00	Add new	>

Special calendar: Add/change connection time	
Day:	21.12.2015 Time: 11:30
Mode:	Big temp. drop 
Approve:	Ready

**A temperature drop for a certain length of time is made using the exception calendar as follows:**

Move to exception calendar and press OK. Press OK at the "Add new" row. Press OK and set the time (date and time), for the temperature drop to begin. Press OK.

Press OK at the mode row and select the mode for the controller to switch to at the above set time. You can select "Temperat. drop", "Bigger temp. drop" or "Contin. nominal temperat.".

Press "Ready" to confirm exception calendar control.

The Home/Away control is only in effect if the controller is on automatic control. When you send a Home or Away message, the controller sends back an OUMAN message showing that the HOME or AWAY control is on.

**Deleting a temperature drop from the exception calendar:**

Select the switch moment to be deleted at mode "Delete switch time" and select "Ready" to confirm.

*The amount of temperature drop is given in settings (see p. 112). The pre-increase function can be used when switching from a temperature drop to a nominal temperature. (see p. 48)*

Key word:  
**Exception calendar**

**Exception calendar: (#1) 21.12.15 08:00 BIGGER DROP/  
03.01.16 16:00 AUTOMAATTI/dd.mm.yy hh:mm mode/**

Date	Time	Status
dd.mm.yy	hh:mm	mode

**Mode (status):**  
**BIGGER DROP = bigger temperature drop**  
**DROP = temperature drop**  
**AUTOM = automatic control**  
**CONTIN. NOMIN. = continuous nominal temperature**



# Time and date

## Clock functions -> Time and date

It is important that the time and date are correct, because, e.g., in alarms you can see when the alarm has become activated and when it has become inactive.

The controller's clock automatically makes summer time and standard time changes and registers leap years. The clock has a backup system in case of short power failures.

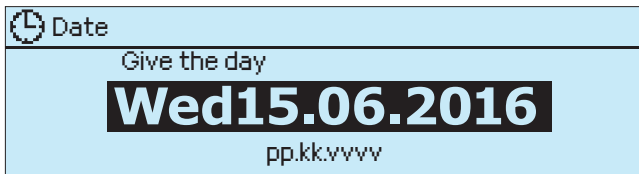
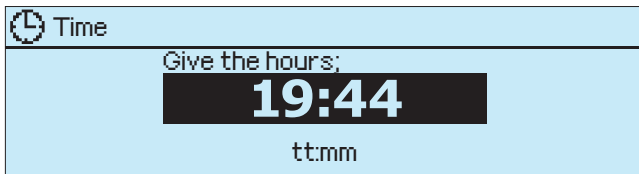
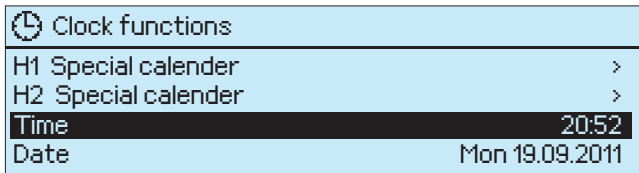

The hours and minutes can be set separately  
Set the hours and press OK to confirm.  
Set the minutes and press OK to confirm.

### Setting the date

First set the day and press OK to confirm.  
Next set the month and press OK to confirm.  
Then set the year and press OK to confirm.  
The day of the week will automatically be updated on the display.  
Press ESC to exit from the time setting mode.

# Alarm notice

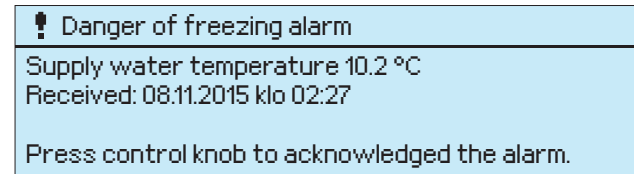

The controller can give an alarm for many reasons. In the event of an alarm, an alarm window pops up which displays exact alarm information.

If there are a number of unacknowledged alarms in the controller, acknowledge the alarm appearing on the display and the previous alarm will appear. When all possible active alarms have been acknowledged, the alarm window will disappear from the display and the alarm will no longer sound.

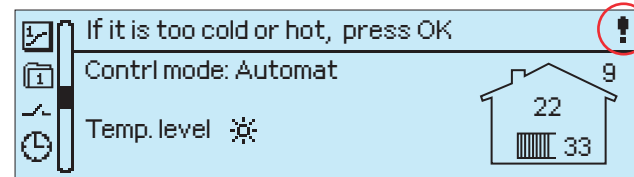

**Acknowledging alarms: Press OK. If the cause of the alarm has not disappeared, the exclamation mark in the right upper will blink.**



# Alarms

## Alarms



You can set alarm limits from the controller's alarm menu. Turn the control knob so the number is outside of the setting range to take the alarm out of use. The text "Not in use" will appear on the display. From the controller's alarm menu you can check the controller's active alarms and what alarms have been active. If the controller has active alarms, the number of active alarms will appear in the main alarm menu.

<b>Room temperature</b> lower limit alarm, 8.0°C      0...95°C freezing risk alarm 5.0°C      0...95°C upper limit alarm 35°C      0...95°C			The room temperature alarm settings are displayed if the room sensor is connected.	Alarms have a 5 second alarm delay.
<b>Supply water</b> lower limit alarm, 8°C      0...95°C freezing risk alarm 5°C      0...95°C upper limit alarm (radiator) 90°C      0...95°C upper limit alarm (floor h.) 50°C      0...95°C				
<b>Supply water deviation alarm</b>	Not in use	1...20°C	The amount of deviation between the measured supply water temperature and the controller determined supply water temperature which causes an alarm when the deviation has lasted for the time of the deviation alarm delay. To take the deviation alarm from use, set the setting outside of the setting range. The deviation alarm is not allowed when; heating is on summer stop (see p. 13), the controller is not on automatic or during the summer when the outdoor temperature is above 10°C and the supply water temperature is below 35°C.	
<b>Delay of supply w. deviation alarm</b>	60min	0...120min	A deviation alarm is given if the deviation is enough to cause an alarm (see the previous setting) and it lasts for the time period set here.	
<b>Return water lower and upper limit alarm</b>	4°C 95°C	0...95°C 0...95°C	The controller gives a return water freezing risk alarm in addition to a lower and upper limit alarm. The alarm limit for the freezing risk alarm is determined by the calculated return water temperature (see p. 50).	
<b>Boiler's lower and upper limit alarm</b>	40°C 95°C	0...95°C 0...95°C	The setting appears if measurement 3 or 4 is reserved for this purpose. The alarm has a 5 second alarm delay.	
<b>Accumulator's lower and upper limit alarm</b>	40°C 95°C	0...95°C 0...95°C		
<b>Measur. 3 (4) lower- and upper limit alarm</b>	5°C 95°C	0...95°C 0...95°C	A free lower limit temperature alarm that can be labelled. A free upper limit temperature alarm that can be labelled.	

# Alarms

## Active alarms:

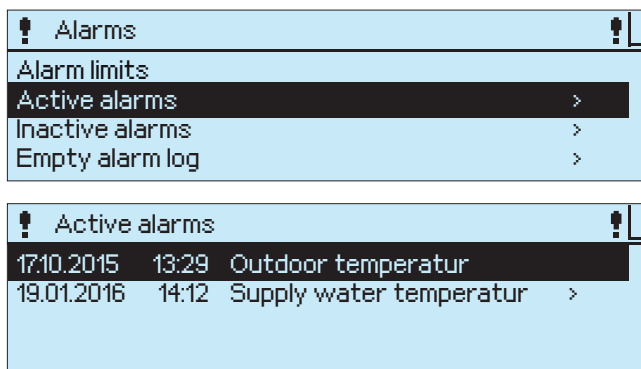

Each active alarm is displayed on a separate row with its activation date. Press OK at the alarm row for more information about the alarm.

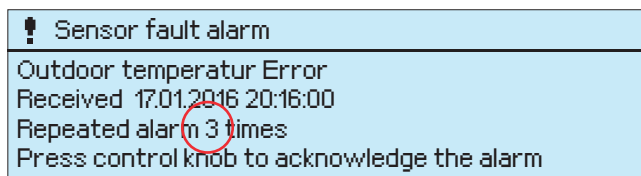

If the controller repeatedly gives an alarm for the same reason, the number of times the controller has given the alarm appears on the display.

## Inactive alarms:

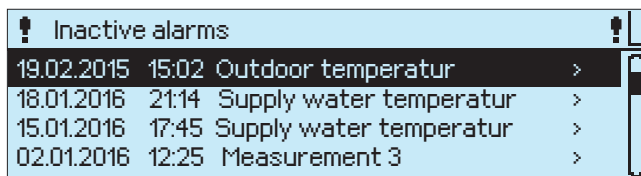

Inactive alarms can be read from the alarm history. From alarms you can see the cause of the alarm, where the alarm has come from and when the alarm has become inactive. (e.g., 19.09.2015 at 15:55:10). The last 10 alarms can be seen in inactive alarms.

## Emptying the alarm history:

The controller asks for confirmation before it empties the alarm history.

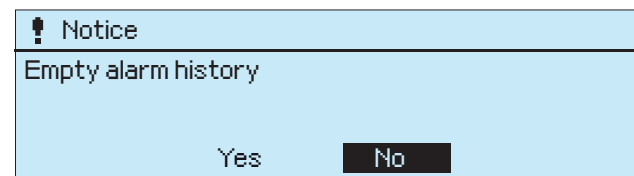

## Relaying alarm information to a mobile phone:

If a modem has been connected to the controller and a phone number has been given to which the alarm is sent, the controller also sends alarm information to the mobile phone. Alarm information can be sent to a mobile phone immediately after the alarm has arrived. The controller first sends information about the alarm to alarm number 1 and if the alarm is not acknowledged in 5 minutes the controller sends the message again to numbers 1 and 2. If the same alarm is repeated a number of times in a 24 hour period, the controller only sends information about 5 alarms / 24 hours.



## Device settings: Language/ Kieli/Språk

### Device settings -> Language/ Kieli/Språk

The language of the controller can be changed.

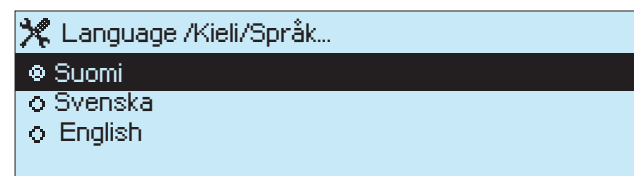

Press OK, change language and press OK.

# ✂ Device settings: Measurement channel settings

## Device settings-> Measurement channel settings

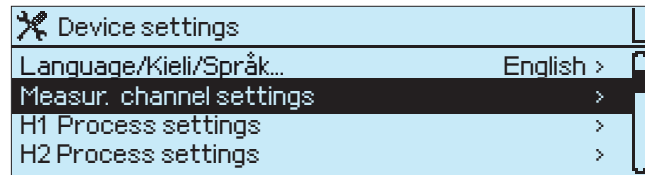

1.

The EH -800 controller has 4 measurement channels. If an extension unit EXU-800 is connected to the controller, the controller has 6 measurement channels.

Measurement channel 1 is reserved for outdoor temperature measurement. The controller has its own plug-in for an outdoor temperature sensor. If the controller is used as a constant temperature controller, the outdoor temperature measurement can be activated or inactivated at this point.

An H1 supply water sensor is already connected to measurement channel 2.

Measurement channels 3 and 4 are connected to the controller using a connecting cord. Select the use for the measurement channels at this point. You can select a measurement connected to room compensation, a factory set temperature measurement or different alarm uses (contact information) as well as home/away switch use. "Measurement 3", "Measurement 4" and "Alarm" can be freely labelled according to their use.

Measurements 5 and 6 can be taken into use if an extension unit EXU-800 has been connected to the controller.

**Trend sampling interval:** Here you can set trend sampling interval that is common for all measurements (see p. 8).

### Example: Measurement 3 for room temperature measurement

1. Move to Device settings and press OK.
2. You can see from the display if measurement channels have been taken into use. Press OK.

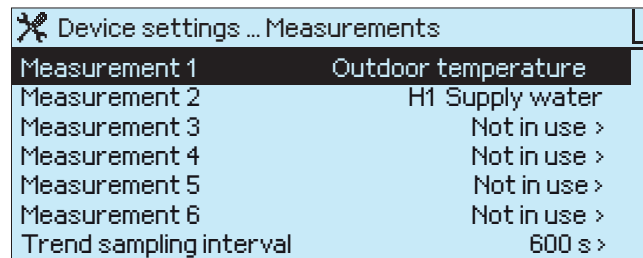

2.

3. Select the measurement channel use. (additional information about uses on the next page). Press OK.
4. Measurement channel 3 is now being used for room temperature measurement.

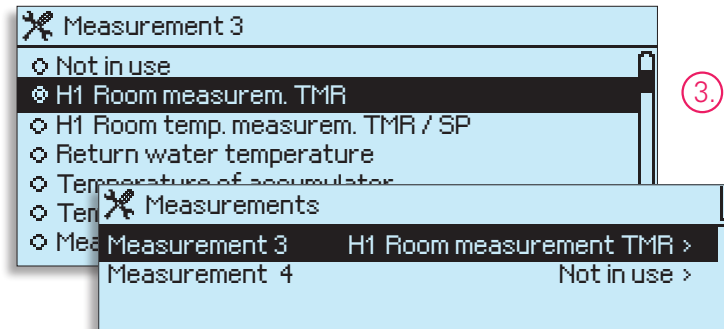

3.

4.

### Example 2. Measurement 4 for alarm use

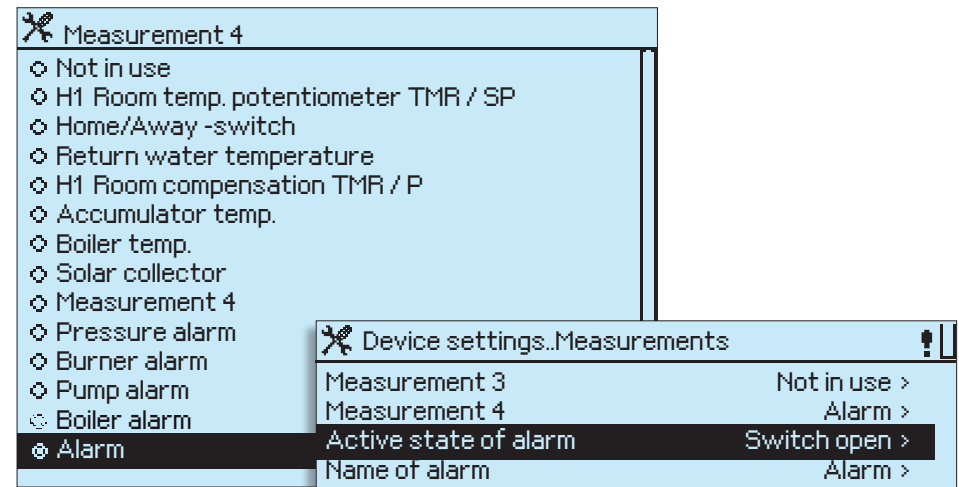

1. The most common alarms have already been programmed into the controller. Select "Alarm" to use alarms that can be freely labelled.
2. Give the alarm a descriptive label. Use the control knob to select a letter and press OK to confirm. When the label is ready, press OK for a number of seconds.
3. Select either an opening or closing alarm. Exit with ESC.



Measurement	Measurement channel	Measurement information
<b>Outdoor temperature</b>	1	If the controller is taken into use as a constant temperature controller, the outdoor temperature measurement is activated here and also inactivated if necessary.
<b>H1 Supply temperature</b>	2	H1 control circuit's supply water sensor connected to the controller.
<b>Room temperature TMR</b>	3 and 4	The controller uses the TMR room sensor to measure the room temperature. The controller uses measurement information when it adjusts the room temperature according to set values. Connect the H1 control circuit room temperature measurement to measurement channel 3 and the H2 control circuit room temperature measurement to measurement channel 4.
<b>Room temp. measurement. / potentiometer TMR/SP</b>	3 and 4	The room sensor (TMR) is connected to measurement channel 3 and the potentiometer (SP) to channel 4. The potentiometer (SP) can be used to make changes from -5°C to +4°C in the room temperature setting. The TMR/SP affects the H1 control circuit.
<b>Room compensation unit TMR/P</b>	3	The room compensation unit (TMR/P) measures changes in room temperature and if necessary, adjusts the supply water temperature so that the desired room temperature is reached. Use the TMR/P knob to steplessly set the desired room temperature between +16°C - +24°C. The point in the middle is equivalent to a room temperature of about 21°C. The TMR/P is often already installed in renovation locations having EH-80. The TMR/P affects the H1 control circuit.
<b>Home / Away -switch</b>	4 or 6	Turn the Home/Away switch to the off mode (status) (contact closes) to make a "Temperature drop". Setting the amount of temperature drop: see p. 12. The home/away switch affects control circuits H1 and H2.
<b>Return water temperature</b>	3 or 4	The controller uses return water meas. information for control and can raise or lower the supply water temperature if necessary. The controller gives a lower limit alarm if the return water temperature falls under +5°C and an upper limit alarm if the return water temp. rises above 95°C.
<b>Boiler temperature</b>	3, 4 or 5	Boiler temperature meas. information. Lower limit alarm +45 °C, upper limit alarm +95°C.
<b>Accumulator temperature</b>	3, 4 or 5	Accumulator temp. meas. information. Lower limit alarm +2 °C, upper limit alarm +95°C.
<b>Solar collector</b>	3, 4 or 5	The solar collector's temperature measurement information. Make sure that the temperature sensor can be used for this.
<b>Measurement 3 (4, 5):</b>	4, 5 or 6	The meas. can be labelled. The controller gives a lower limit alarm if the temp. falls below -50°C and an upper limit alarm if the temp. rises above 130 °C. If the meas. is not labelled, it will read meas. 3(4, 5) on the display.
<b>Pressure alarm</b>	4, 5 or 6	Alarm information from a pressure switch connected to the heating network.
<b>Burner alarm</b>	4, 5 or 6	Alarm information about burner malfunction
<b>Pump alarm</b>	4, 5 or 6	Alarm information from a water circulation pump.

# Measurement channel settings

Measurement	Measurement channel	Measurement information
<b>Boiler alarm</b>	4, 5 or 6	Alarm information from a boiler's thermostat.
<b>Spark alarm</b>	4, 5 or 6	Alarm information from a spark detector connected to the controller which has detected a spark and/or glowing particle (danger of fire from flying sparks in pellet and chip boilers) The VMR100 spark detector and the Atexon extinguishing system have been tested to be controller compatible. When the spark detector has detected a spark or glowing particle, the contact closes and the controller gives off a spark alarm.
<b>Alarm</b>	4, 5 or 6	Alarm that can be freely labelled.

## Connecting sensors

EH-800 cords with plugs

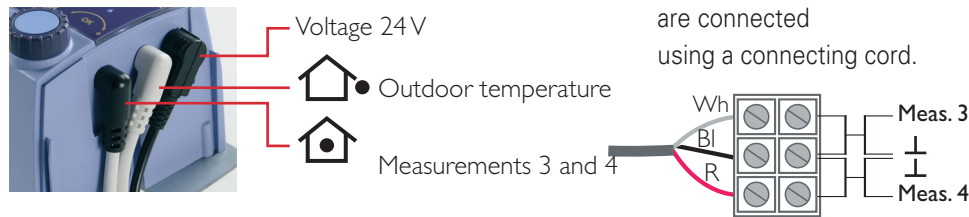

## Connection of measurements 5 and 6 using the extension unit

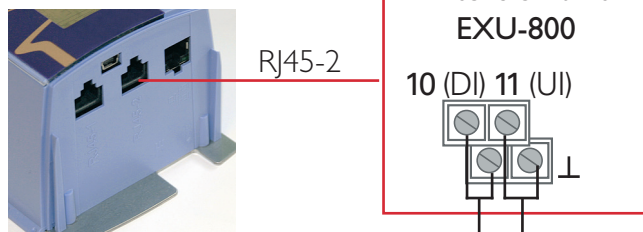

RJ45-2 plug connection



Measurement 6: contact information (alarm or home/away)

Measurement 5: H<sub>2</sub> supply water temperature, if regulator is double circuit heating controller  
Other temperature measurement or contact information, if regulator is a single circuit heating controller.

Setting	Factory setting	Setting range	Information about the setting:
<b>Trend sampling interval</b>	600 s	30...21600 s	This setting is common for all measurements. In the EH-800 model, you may download a trend file to your pc via controller web page. You may examine trend via browser using Ouman Trend software. Go to <a href="http://www.ouman.fi">www.ouman.fi</a> to download the software.

 Measurement 5	 Measurement 6
<ul style="list-style-type: none"> <li><input checked="" type="radio"/> Not in use</li> <li><input type="radio"/> Temperature of accumul</li> <li><input type="radio"/> Temperature of boiler</li> <li><input type="radio"/> Measurement 5</li> <li><input type="radio"/> Pressure alarm</li> <li><input type="radio"/> Burner alarm</li> <li><input type="radio"/> Pump alarm</li> <li><input type="radio"/> Boiler alarm</li> <li><input type="radio"/> Spark alarm</li> <li><input type="radio"/> Alarm 5</li> </ul>	<ul style="list-style-type: none"> <li><input checked="" type="radio"/> Not in use</li> <li><input type="radio"/> Home/Away -switch</li> <li><input type="radio"/> Pressure alarm</li> <li><input type="radio"/> Burner alarm</li> <li><input type="radio"/> Pump alarm</li> <li><input type="radio"/> Boiler alarm</li> <li><input type="radio"/> Spark alarm</li> <li><input type="radio"/> Alarm 6</li> </ul>

# ✂ Device settings: H1 Process settings/ Heating mode

Device settings -> H1 Process settings -> Heating mode

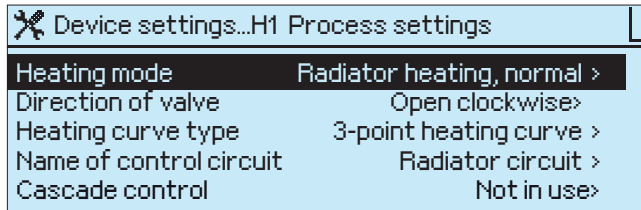

## Heating system-specific process settings are:

- selection of heating mode
- selection of valve direction
- selection of curve
- naming the control circuit
- taking cascade control into use (an extension unit must be connected to the controller)

The selection of the heating mode and valve direction occurs when the controller is taken into use but later on they can be changed from here.

The selected heating mode appears in the Process settings display. To change what you have selected, press OK and move to the setting you want to change and press OK, and a window will open for that setting.

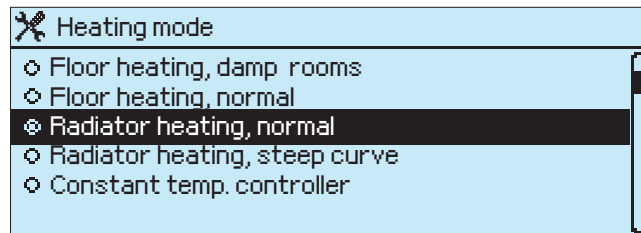

### Symbols

= floor heating  
 = radiator heating

The controller has factory set basic settings for the different heating modes which usually do not have to be changed.

**Radiator heating, normal:** this heating mode is a factory setting.

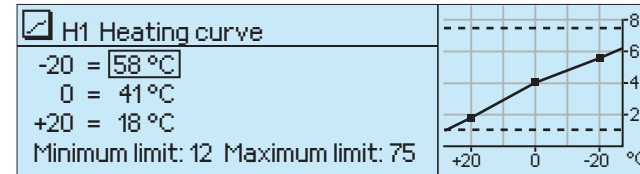

The curve is equivalent to the C curve of the EH-80 controller.

**Radiator heating, steep curve:** for a location requiring higher than normal temperatures in its heating system (less insulation or size of the heating system).

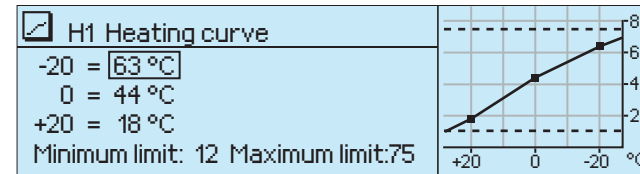

**Floor heating, normal:** for the average residence.

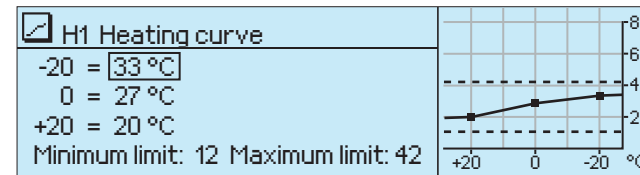

**Floor heating, damp areas:** e.g., for rooms having tile which are also heated in the summer.

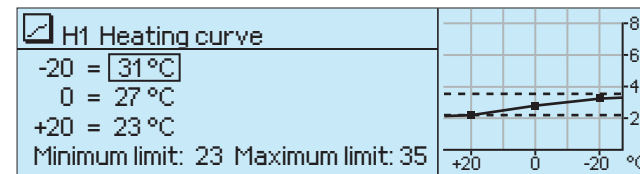

The supply water minimum limit setting ensures that damp rooms feel comfortable and maintain a drying temperature in the summer.



# Heating mode

Device settings -> H1 Process settings -> Heating mode

## Constant temperature controller:

The controller keeps the supply water temperature constant regardless of the outdoor temperature (special use). The factory set supply water is 15.0 °C, the supply water minimum limit is 5.0 °C, and the maximum limit is 95.0 °C. The outdoor temperature measurement can be taken into use (device settings/ measurement initiation).

## Drying a concrete floor:

Concrete floor drying	
 Supply water temperature	22.1 °C
 Supply water setting	15.0 °C
The rate the supply water setting is raised 1.0 °C/24 h	
Supply water maximum limit	30 °C

The concrete drying function is used in new locations when drying the concrete floor. The supply water temperature is gradually raised to the maximum setting. If the valve does not open clockwise, change the direction of the valve in device settings (see next page). Concrete floor drying cannot be taken into use if the H2 control circuit has been taken into use.

## Factory settings for concrete drying

Setting	Factory setting	Setting range	Information about the setting:
<b>Supply water setting</b>	15 °C	0.0...95.0 °C	A supply water setting is given here which the controller starts raising according to the rate set in settings.
<b>Speed of increase of setting</b>	1.0 °C / 24 h	0.0...50 °C / 24 h	The concrete floor must be dried slowly to prevent the concrete from cracking.
<b>Supply water max. setting</b>	30.0 °C	0.0...95.0 °C	The supply water temperature maximum limit. The controller raises the supply water setting at the set rate to this limit, after which the temperature remains at this level.

**Special application for the constant temperature controller:**  
 When the controller is being used as a constant temperature controller, the set temperature for the supply water can be compensated with the room temperature measurement and the supply water minimum limit can be raised with the outdoor temperature measurement. (see Device settings/Measur.channels setting). Example: the swimming pool application. Install the supply water sensor to the pipe going from the heater to the swimming pool. Install the other surface sensor to the water pipe coming from the swimming pool and connect it to the controller at the room sensor spot. The controller will correct the supply water temperature with the room compensation function so that the return water temperature will remain at the set room temperature. If the swimming pool is outdoors, install the outdoor temperature measurement. Then you can set the supply water minimum limits according to the outdoor temperature to minimize the freezing risk.

# ✂ Valve direction

Device settings-> H1 Process settings -> Direction of valve

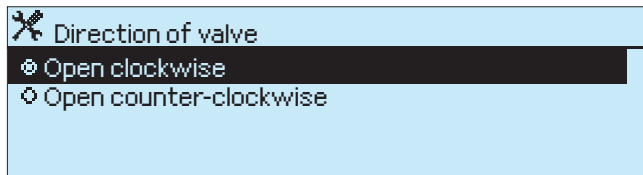

Select the direction for the valve to open here. The valve opens clockwise as a factory setting.

If the valve opens clockwise:

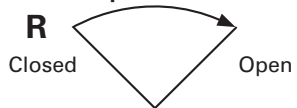

If the valve opens counterclockwise:

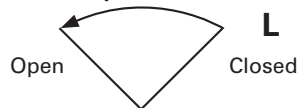

The range of movement of boiler valves is mechanically limited to 90°. Therefore, it is easy to find the limits by turning the valve to the extreme limits using the manual control knob or axle. Sometimes it may be difficult to determine the opening direction of a 3-way valve installed in the network, e.g., if the manual control knob is missing or the scale plate of the valve is installed incorrectly. To make it easier to determine the direction, a few hints are given below for the most common mixing valves on the market.

**ESBE (3MG):** The slide of the valve can be turned 360°. Turn the valve all the way to the left (9 o'clock). The tapered side of the valve axle always faces toward the slide. (the branch on the tapered side is closed).

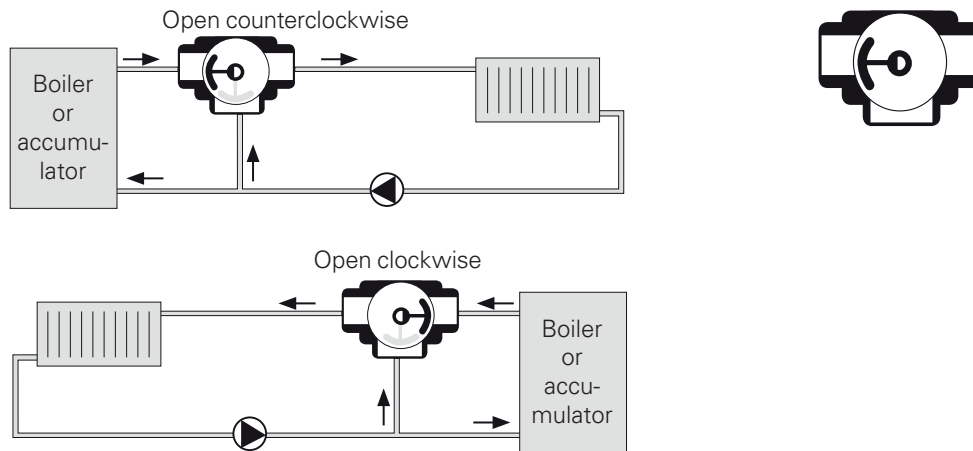

**TERMOMIX:** The side of the valve is always on the side opposite to the taper at the end of the axle.

If you can't get the valve turned so that the slide moves between the hot water branch and circulating water branch, the position of the valve cover must be changed. We recommend having a plumber change the direction because of the risk of water damage and burns.

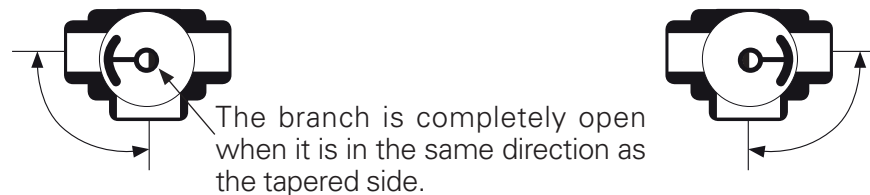

# ✂ Selecting the type of curve

Device settings -> H1 Process settings -> Heating curve type

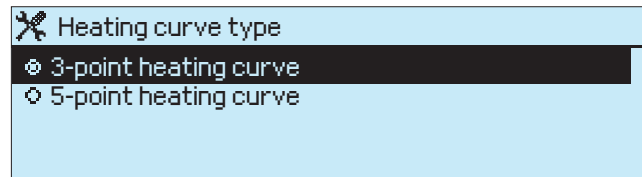

Select either a 3 point or 5 point curve here. A 3 point curve is the default, so the controller prevents selection of a curve of the wrong shape.

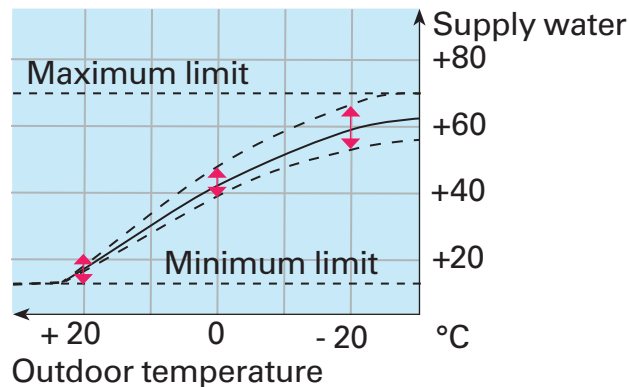

**3 point curve:** The supply water temperature is set at outdoor temperatures of -20°C, 0°C and +20°C. The controller prevents an incorrectly shaped curve from being set by automatically correcting the curve.

A **5 point curve** offers even more possibilities to make a curve of just the right shape to exactly meet the heating need of your facility. A 5 point curve does not have automatic correction of incorrectly shaped curves.

The 5 point curve is adjusted in the H1 Heating curve menu as follows: Set the supply water temperatures for outdoor temperatures +20, +10, 0, -10 and -20 °C.

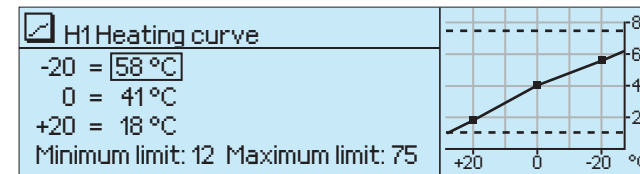

Press OK for a number of seconds to change the setting points for outdoor temperatures between +20 and -20°C (the factory set points are +10, 0 and -10°C).

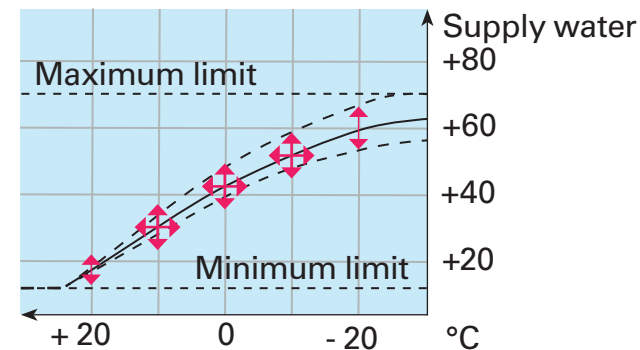

# Control circuit name

Device settings-> Process settings -> Name of control circuit

The EH-controller automatically names the control circuit according to the selected heating mode (radiator heat, floor heat, damp rooms, constant heating controller). It can change the name or the control circuit if you want to. You can name the control circuit, e.g., according to a certain area (downstairs, upstairs, tiled rooms). H1 or H2 will always appear before the name to indicate the control circuit.

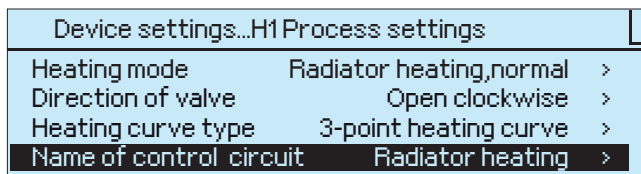

The name of the control circuit appears in the controller's menu on the top row.

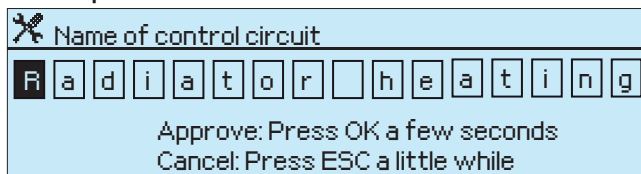

## Labelling:

Turn the control knob and press OK to confirm.  
Press OK to move to the next square.  
Press ESC to return to the previous square.



Press OK for a number of seconds to confirm the name.  
Press ESC for a few seconds to cancel the name change.

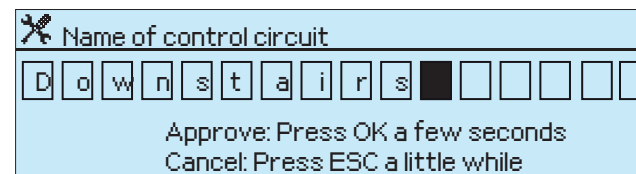

An example of labelling the control circuit. The new name will appear in the upper section of the basic menu.

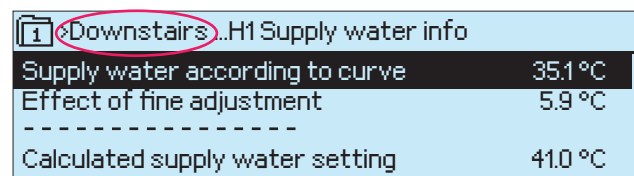

# ✂ Cascade control

Device settings -> H1 Process settings -> Cascade control

Cascade control makes it possible to combine two heating modes. Cascade control requires that either EXU-800 extension unit or EXP-800 expansion package has been connected to the controller. This makes it possible to control two valve actuators at the same time.

With cascade control, first open the cascade control valve (TV1) and then the valve that is connected to the EH-800 controller (TV2). The heating circuit's supply water sensor that is already connected to the EH-800 controller can be easily connected to the supply water pipe approximately one meter from the valve (see the diagram).

Example: Use a solar collector or air-to-water heat pump as a primary source of heat. When the controller has opened the cascade control's valve actuator (connected to the extension unit) to full speed, the controller begins opening the other heating source's valve that is connected to the EH-800 controller. The other source of heat can be, e.g., an oil burner.

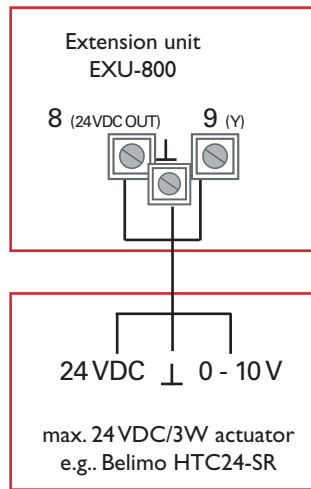

Cascade control actuator connection to EXU-800 extension unit.

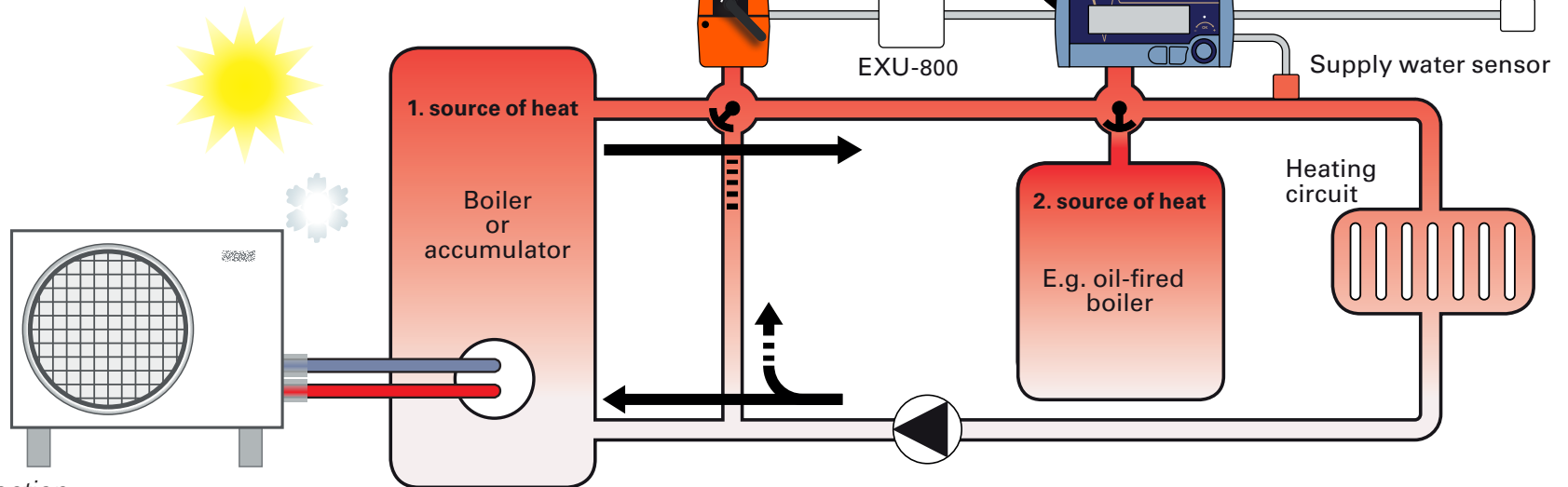

A diagram illustrating cascade control. For more diagrams, see [www.ouman.fi](http://www.ouman.fi).

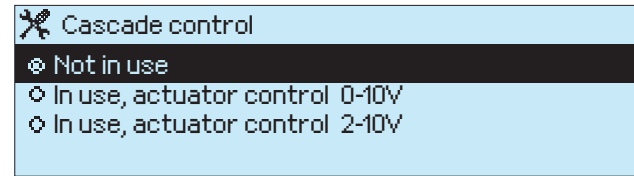

Select either 0-10 V or 2-10 V control.

The power supply coming from the EH-800 controller to the extension unit is sufficient for an actuator having a maximum of 24VDC/3W (e.g., Belimo HTC24-SR) (connection to the extension unit's strip connectors 7 or 8). If you use a higher-powered actuator or an ac-powered actuator, the power must be supplied by a separate transformer and only 0 (2) ...10V control is taken from the extension unit (strip connector 9).



# ✂ Hybrid heating

## Device settings -> Hybrid heating

Hybrid heating uses two parallel heating systems. The more inexpensive heat source is used as much as possible and the parallel system is used as needed, for example, during long periods of very low subzero temperatures when additional heating capacity is needed. Hybrid heating may use, for example, solar collectors as the primary heat source, and any traditional heat source, such as oil or electricity, as the secondary heat source (see the diagram).

Hybrid heating uses relative power control, which helps obtain better efficiency than with cascade control (see p. 32). In hybrid heating control, it is also possible to cool the accumulator if it overheats. Cooling may be necessary, for example, in solar heating if the accumulator is small and the solar collectors produce too much heat.

Hybrid heating control requires that either EXU-800 extension unit or EXP-800 expansion package has been connected to the controller. If hybrid heating has been selected in the controller, H2 circuit is not available.

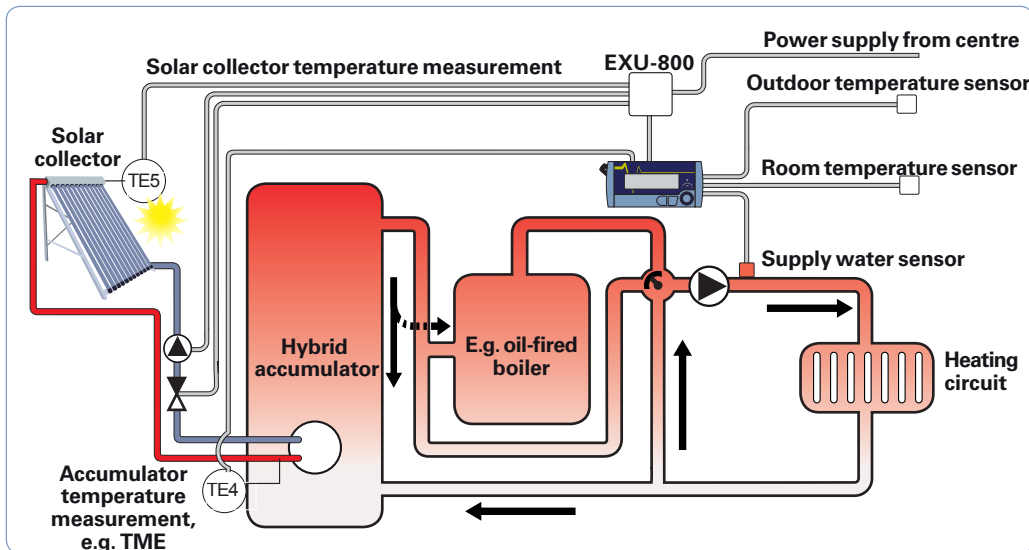

A diagram illustrating hybrid heating control. See [www.ouman.fi](http://www.ouman.fi) for more diagrams.

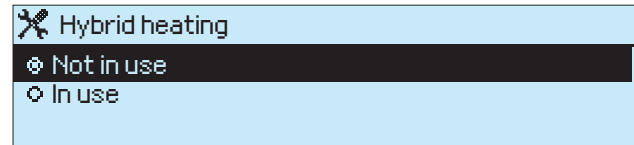

Hybrid heating can not be taken into use if:

1. Cascade control has been taken into use (see Device settings -> H1 process settings -> Cascade control).
2. H2 circuit is in use (see Device settings -> H2 Process settings).
3. Relay control has been taken into use (See Device settings -> Relay control).

If "Hybrid heating" is not selectable in device settings, make sure that cascade control, H2 circuit and relay control are in "Not in use" state.

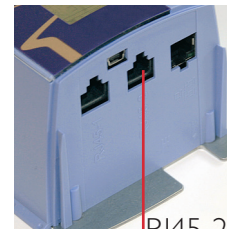

RJ45-2 plug connection

When hybrid heating is taken into use, the controller automatically reserves measurements 4 and 5 to hybrid heating use. Accumulator temperature measurement is connected to measurement channel 4, and solar collector temperature measurement is connected to measurement channel 5.

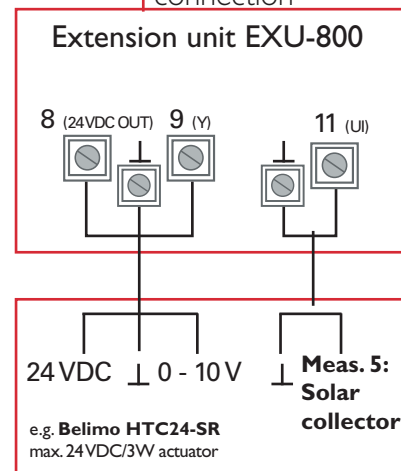

Connecting charge pump actuator and solar collector temperature sensor to EXU-800 extension unit.

EH-800 cords with plugs

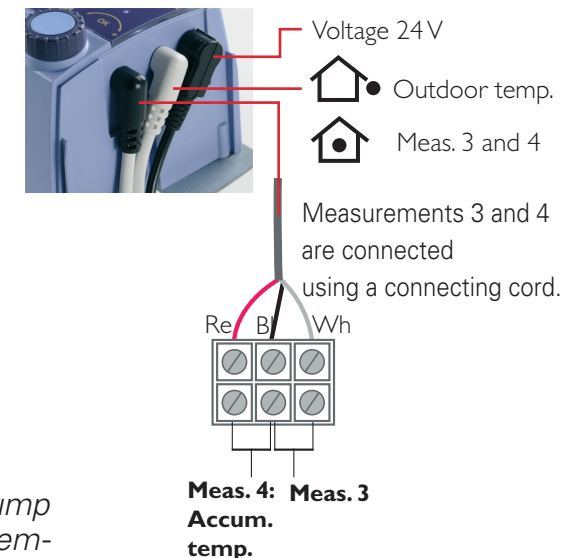

# ✂ Hybrid heating

## Device settings -> Hybrid heating

Setting:	Factory setting	Setting range	Information about the setting:
<b>Hybrid heating</b>	Not in use	Not in use In use	If hybrid heating is taken into use, the controller automatically reserves measurement channels 4 and 5 to hybrid heating temperature measurements (meas. 4 for accumulator temperature, meas. 5 for solar collector temperature). The function requires that either EXU-800 extension unit or EXP-800 expansion package has been connected to the controller.
<b>Actuator selection</b>	0-10 V	0-10V or 2-10V	Select whether to use a 0-10 or 2-10V voltage-controlled actuator in the charging circuit.
<b>Charging control</b>			
<b>Temp. difference where valve is 100%</b>	20 °C	0...100 °C	The extent of temperature difference between the accumulator and the charging circuit (e.g. solar collector) at which valve is driven 100 % open.
<b>Charging circuit valve min position</b>	10 %	0...100 %	The position of the valve is determined by the extent of the temp. difference between the accumulator and the charging circuit. If the temp. difference is small, the valve is driven towards 'Closed' position, and thus the flow gets weaker and the temp. difference gets bigger. This setting determines the minimum valve position when the pump is running.
<b>Temp. difference where pump starts</b>	10 °C	0...20 °C	The charge pump is relay-controlled. The pump starts when the temperature difference between the accumulator and the charging circuit equals this setting.
<b>Temp. difference where pump stops</b>	2°C	0...20 °C	The pump stops when the temperature difference between the accumulator and the charging circuit equals this setting.
<b>Cooling function</b>			
<b>Cooling</b>	Not in use	Not in use, In use	As a factory setting, cooling is not in use. It is recommendable to use the cooling function if there is a risk of the accumulator overheating. Overheating may take place if, for example, the accumulator is small and the solar collectors produce too much heat.
<b>Cooling starts when accumulator temp. is</b>	95 °C	0 ... 100°C	Charge pump starts and the valve is driven 100% open when the accumulator temperature rises to equal this setting. In addition, the charging circuit temperature must be at least the extent of "Temp. difference where pump starts" below the accumulator temperature. Moreover, outdoor temperature mustn't be below "Outdoor. temp limit for cooling".
<b>Cooling stops when accumulator temp. is</b>	80 °C	0 ... 100°C	Cooling stops when the accumulator temp. drops enough to equal this setting. Or when the temp. difference between the accumulator and the charging circuit shrinks enough to equal the setting "Temp. difference where pump stops". This is when the charge pump stops and the valve is driven closed.
<b>Outdoor. temp limit for cooling</b>	12 °C	0 ... 50°C	The outdoor temperature limit below which cooling function is blocked.

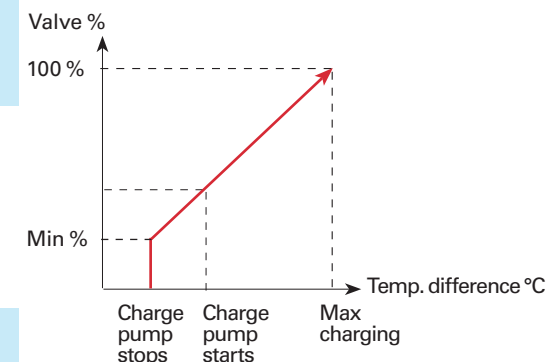

Initiation of the second control circuit and relay controls on page 35-37. These functions can be taken into use if the controller is connected to the extension unit, OUMAN EXU-800 (optional equipment).

## H2 Process settings

Device settings -> H2 Process settings -> Heating mode

The extension unit, supply water sensor and the second control circuit's actuator are optional equipment that must be obtained separately. Connect the H2 supply water sensor and the H2 circuit actuator to the extension unit. Connect the extension unit to the controller via the RJ45.2 connector.

Taking the H2 control circuit into use:

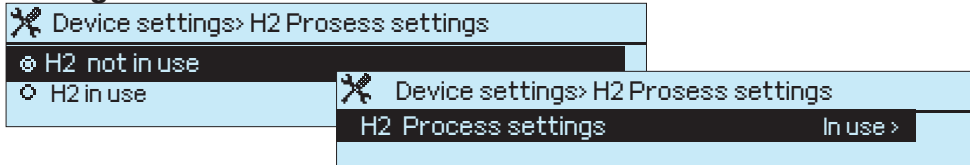

When the H2 control circuit is taken into use, the controller automatically reserves regulators's measurement channel 5 for the H2 supply water temperature measurement.

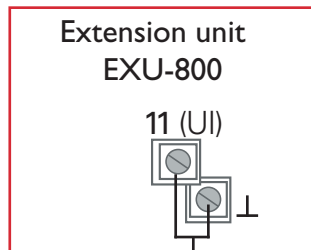
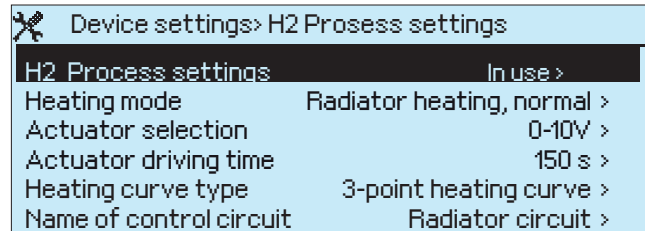

H2 Supply water sensor (channel 5 in regulator)

*H2 Supply water sensor connection*

Heating mode:

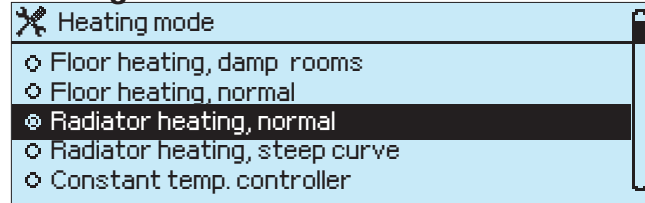

The controller automatically labels the H2 control circuit according to the selected heating mode. Additional information about different heating modes on p. 27.

Actuator selection:

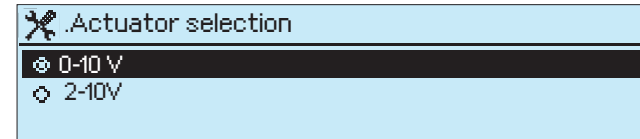

A 24VDC-controlled actuator can be used in the H2 control circuit. The power supply coming from the EH-800 controller to the extension unit is sufficient for an actuator having a maximum of 24VDC/3W (e.g., Belimo HTC24-SR). (connection to the extension unit's strip connectors 7 or 8). If you use a higher-powered actuator or an ac-powered actuator, the power must be supplied by a separate transformer and only 0 (2) ...10V control is taken from the extension unit (strip connector 9).

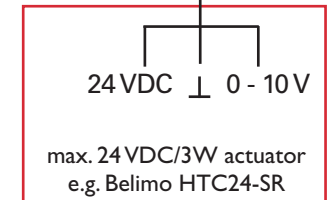
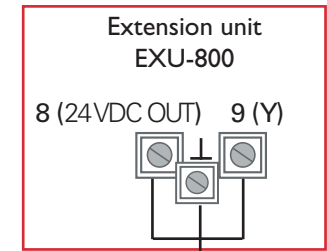

*H2 actuator connection*

Actuator driving time:

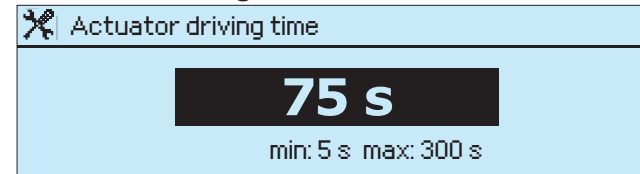

Give the actuator a run time. The run time indicates how many seconds go by if the actuator drives a valve nonstop from a closed position to an open position.

Selecting the control circuit type:

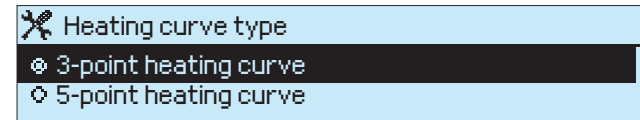

Here you can select whether to use a 3 point or 5 point curve. A 3 point curve is a default and the controller prevents selection of a wrong-shaped curve. Additional information about curves on p. 30.

Changing the name of a control circuit:

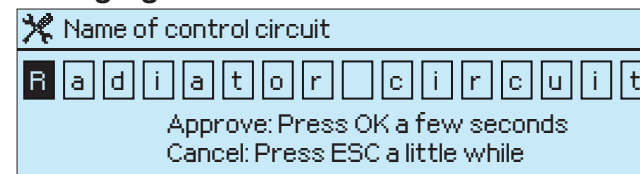

See page 31.

# ✂ Relay control

## Device settings -> Relay control

Relay control can be taken into use if an extension unit has been connected to the controller using an RJ45-2 channel. Select the relay use.

✂ Device settings > Relay control

- Not in use
- Pump summer stop
- According to the temperature
- Accord. to temp. difference
- Accord. to H1 valve position
- Accord. to the time program
- General alarm

### Pump summer stop:

✂ Device settings > Relay control

Relay control Pump summer stop

Summer function (outdoor temp. limit) 19°C >

Valve position at summer function In control >

Give the controller an outdoor temperature limit at which it stops. The controller is given an outdoor temperature limit at which the controller is stopped. You can select here or in H2 control circuit special settings either to close the H2 valve or keep it on control when the pump stops (see p. 50). Connect the pump to the extension unit's row connectors 21 and 23. The 230 V power source that the pump requires can be taken through the external source ( see separate instructions).

✂ Summer function (outdoor temp. limit)

**19°C**

min: 5 max: 95.0

✂ Valve position at summer function

- In control
- Closed

## Relay control according to the temperature:

✂ Device settings > Relay control

Relay control According to the temperature >

Meas. that controls the relay Boiler temp. >

Setting at which the relay is active 58°C >

Hysteresis 5°C >

Relay is active: When meas. drops below setting >

✂ Meas. that controls the relay

- Measurement 1 Outdoor temperature
- Measurement 2 H1 Supply water
- Measurement 3 H1 Room measurem. TMR
- Measurement 4 Solar collector
- Measurement 5 Boiler temp.
- Measurement 6 Not in use

Select which temperature controls the relay. If the measurement channel has not been taken into use or you want to use it for something else, make the change at "Measurement channel settings" in device settings.

✂ Setting at which the relay is active

**55 °C**

min: 0 max: 95

✂ Hysteresis

**3 °C**

min: 1 max: 10

✂ Relay is active:

- When meas. drops below setting
- When meas. goes above setting

**"When meas. drops below setting"**: Relay control switches on when the temperature drops to the set value and switches off when the temperature rises the amount of the hysteresis above the set value. Use this, e.g., when controlling an additional source of heat on (e.g., electric heater) or in an automobile heater outlet.

**"When meas. goes above setting"**: Relay control switches on when the temperature rises to the set value and switches off when the temperature drops the amount of the hysteresis below the set value. This can, e.g., control a cold room's compressor or heat distribution room's fan.

## Relay control according to the temperature difference:

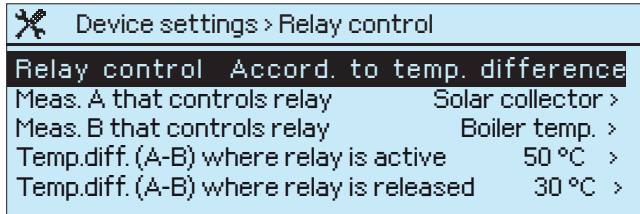

Relay control is activated when the difference between two temperatures is large enough. Example: Solar collector/ Boiler temperature.

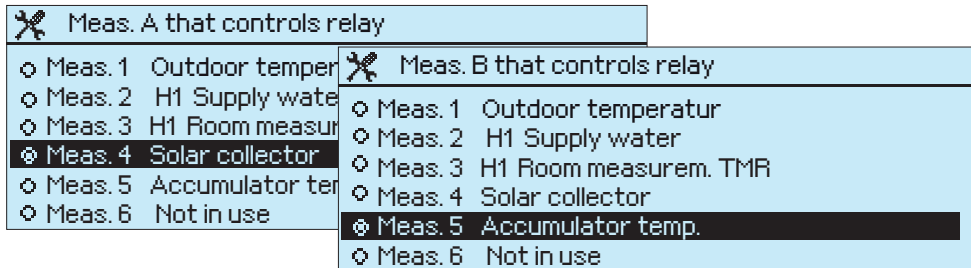

Here you can select which temperature differences control the relay. Subtract temperature measurement B from temperature measurement A. If the measurement channel has not been taken into use or you want to use it for something else, make the change at “Measurement channel settings” in device settings.

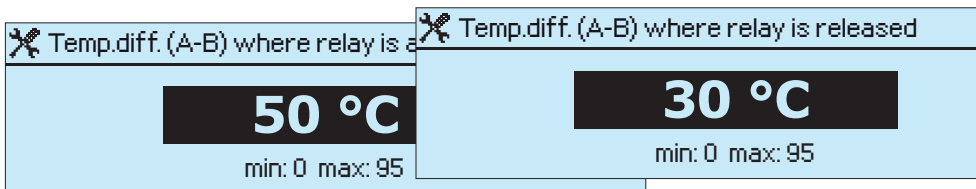

### Temperature difference (A-B), when the relay is active (ON):

The right temperature difference between the solar collector and boiler could be, e.g., 10 °C. When the temperature of the solar collector is, e.g., 10 °C higher than the boiler temperature, the solar energy collector’s circulating pump is controlled on.

### Temperature difference (A-B) when the relay is released (OFF):

If the relay continuously becomes active and then released, the setting is too small.

## Relay control according to the valve position::

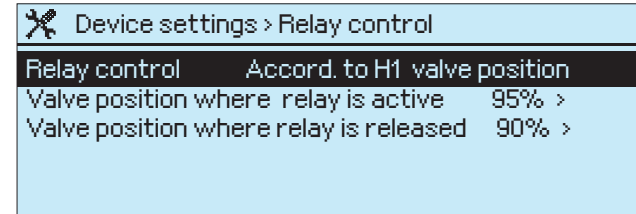

Relay control is activated when the valve has opened enough. Example: At first the water in the boiler is heated using more inexpensive energy (e.g., an air-to-water heat pump). When the valve is 95% open a run command is given to the oil burner. The oil burner is turned off when the position of the valve is 90%.

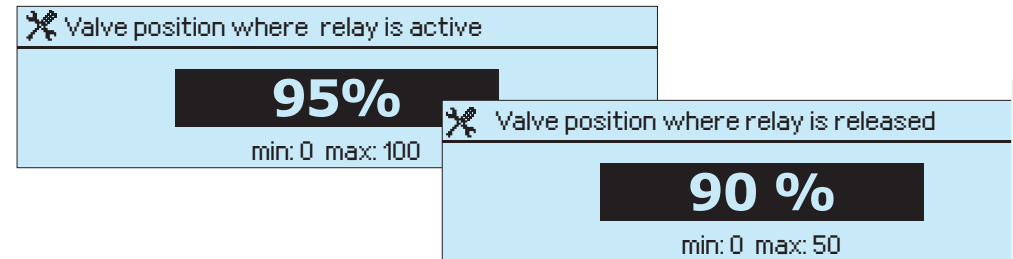

## Relay control according to the time program:



The relay changes its mode according to its week/ 24 hour program. Example: Using electric heat at night for an additional heating source. See p. 18 to create the relay’s week/24 hour program

## Indication of alarm:

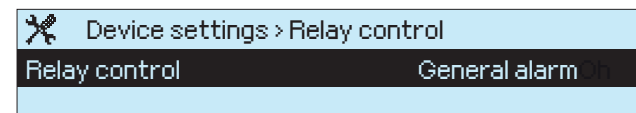

The relay is always activated when the EH-800 controller has an alarm that has not been acknowledged (see p. 17).

# ✂ Valve flushing

## Device settings -> Valve flushing

It pays to take the valve flushing function into use when there are impurities in the fluid circulating in the pipes or if the position of the valve is not changed in a long time (e.g., the summer function is taken into use).

The controller checks the position of the valve at the same time it carries out the flushing function. First it completely closes the valve, then opens it to the flushing position and then to the position determined by the controller.

If the controller is in the pump summer stop mode, it turns the pump on for a few minutes during valve flushing.

✂ Device settings> Valve flushing	
V1 valve position during flushing	20%>
V2 valve position during flushing	20%>
Flushing day	Monday>
Flushing time	08:00>

✂ V1 valve position during flushing

**Not in use**

min: 1 max:100

To take the valve flushing function into use, set the percent that the valve is opened during the flushing function. When the controller flushes it also checks the position of the valve by completely closing the valve, then opening it to the set valve flushing position and then to the position determined by the controller.

✂ Flushing day

Monday

Tuesday

Wednesday

Thursday

Set a date for valve calibration and valve flushing.

✂ Flushing time

**8:00**

min: 0 max:23

Set a time for the valve flushing and calibration. The controller first checks the position of the H1 control circuit valve and flushes the H1 valve. After that it checks the position of the H2 control circuit valve and flushes the H2 valve.

**If the controller has stopped the pump (pump summer stop function), the controller runs the pump when it flushes the valve.**

# ✂ Text message settings

## Device settings > Text message settings

The EH-controller compatible GSM modem makes it possible to communicate with the controller via text message. If an extension unit has been connected to the controller's RJ45-2, then the modem is connected to the extension unit.

### Connect the GSM modem to the controller

#### A. Using the RJ45-2-connection

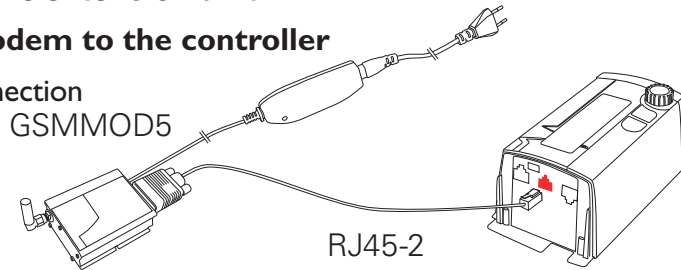

#### B. Using the extension unit

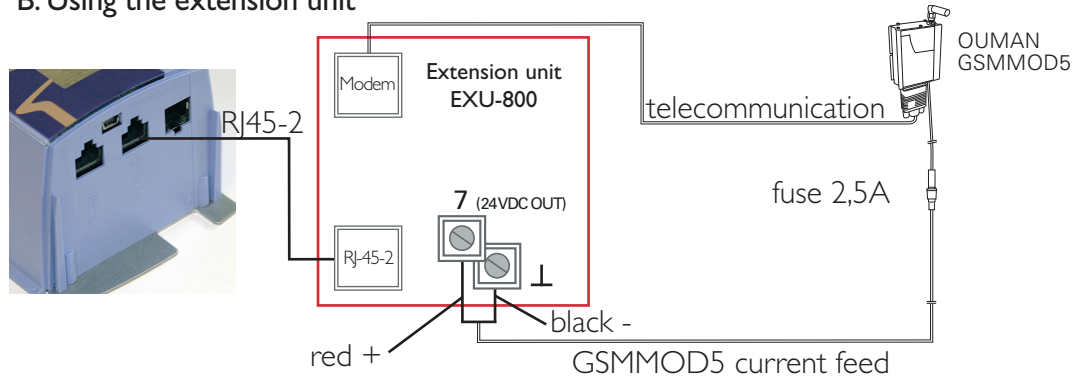

The selections that have been made appear on the display. If you want to make changes, press OK at the row you want to change and a window will open up.



**The controller automatically initializes the GSM modem at 10 minute intervals. This ensures that the GSM connection will continue to work after power failures.**

**Message centre number:** The controller can identify the operator in use from the modem's SIM card. Identification occurs after the PIN is given. If the controller does not identify the operator even though the PIN is correct, write the message centre number. If you change the message centre number, the number is entered on the SIM card. The controller reads the number entered on the SIM card.

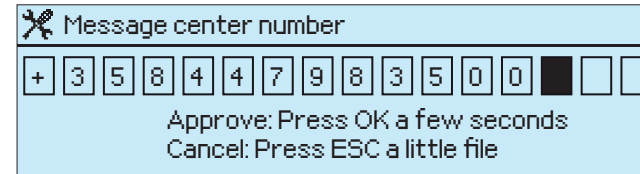

### Message centre numbers:

DNA	+35844 798 3500	Saunalahti	+35845 110 0100
TeliaSonera	+35840 520 2000	Tele Finland	+35840 520 2330
Elisa	+35850 877 1010		

**PIN:** If the SIM card has a PIN inquiry, the controller asks for the PIN.

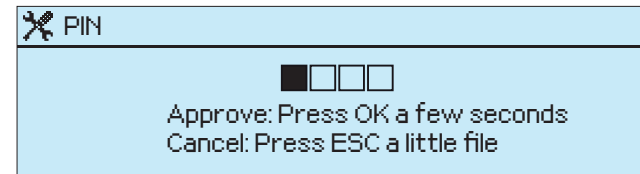

**Device ID:** The controller can be given a device ID that functions as the device's password and location. The device ID can be freely labelled. When communicating with the device using a mobile phone, write the device ID in front of the key word. Note capitals and small letters in the device ID. Clear the fields to take the device ID from use.

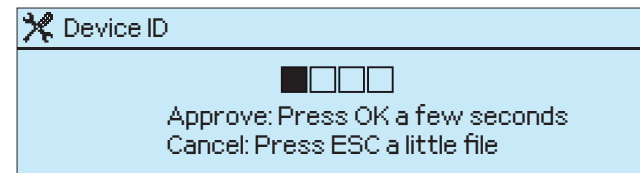

**Alarm numbers 1 and 2:** The controller sends alarm information to two GSM numbers designated here.

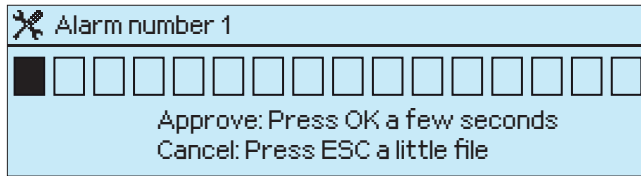

**Giving the number:**  
Turn the control knob and press OK to confirm the number.  
Press ESC to return to the previous square.  
Press OK for a number of seconds to confirm.  
Press ESC for a number of seconds to delete the name change.

The country code does not have to be added to the number. Finland's country code is +358. For example, if the telephone number is 040840400 and you use the country code, enter the number as +35840840400 (the country code replaces the first number of the telephone number).

**When the controller gives an alarm, alarm information is relayed first just to alarm number 1. If the alarm is not acknowledged within 5 minutes after the alarm message has arrived, the controller sends a new text message to alarm numbers 1 and 2. If the same alarm is repeated, the controller can only send a maximum of 5 messages about the same alarm in 24 hours.**



Send the same message back to the controller to acknowledge the alarm.

**Text message limiting (24 h):** You can limit the number of text messages that the controller sends in a 24 hour period here. The controller also has a limiting function that allows only 5 messages to be sent about the same alarm in a 24 hour period.

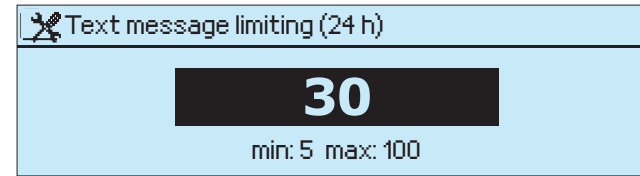



# EH-800 network settings

## Device settings -> Network settings

The EH-800 controller can be connected to the internet or a shielded intranet and can be controlled using a computer's browser. When connecting the device to the internet, Ouman recommends using Ouman 3G internet and information security solution (an installation and configuration guide is included with the product). The user can then control, adjust and monitor building technology regardless of time and place. Internet Explorer and Mozilla Firefox are supported browsers.

If the controller is connected to a network, it has to be given an IP-address, subnet mask and default gateway (internet use) as well as a user name and password. Instructions for entering needed information into EH-800 are in the next section. EH-800B cannot be connected to a network.

### Instructions for connecting the EH-800 device to a intranet:

1. After the PC has been started up select: "Start" -> "Run"
2. Enter "cmd" in the command prompt and select "OK".
3. Enter "ipconfig" in the command prompt and press "Enter".  
EH-800 can be connected to an intranet if the address begins with the following numbers:

- \* 10.x.x.x (esim. 10.2.40.50)
- \* 192.168.x.x (esim. 192.168.0.2)
- \* 172.16.x.x – 172.31.x.x (esim. 172.18.0.5)

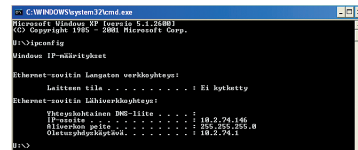

```
C:\WINDOWS\system32\cmd.exe
Microsoft Windows [IP-osoite: 10.2.40.50]
(C) Copyright 1980-2003 Microsoft Corp.
U:\>ipconfig

Osoite IP-osoite
Ethernet-osoite Luotaton verkkoyhteys:
    . . . . . : 10.2.40.50
Ethernet-osoite Ethernet-yhteys:
    . . . . . : 10.2.40.100
    . . . . . : 255.255.255.0
    . . . . . : 10.2.74.1
```

If the IP-address begins with different numbers, it usually means the following:

- \* The service does not have a firewall device, meaning that the service is an unshielded direct connection to a public network. EH-800 cannot be directly connected to a facility's intranet with these settings. Ouman offers a Ouman 3G and Ouman ACCESS remote management products for the solution to this situation.

4. Write down the following information:
  - IP-address, for example, 10.2.74.146
  - Subnet mask, for example, 255.255.255.0
  - Gateway, for example, 10.2.74.1
5. Close command prompt, write exit.
6. In the EH-800 controller go to device settings -> Network settings menu
7. In item 4 write the IP-address on the "IP-address" row of the configure window. Add ten to the last number series row. (e.g., 10.2.74.146 + 10 = 10.2.74.156) Enter the first number and confirm. Then give the second, third and fourth number (the fourth number should be between 1...253. The set number cannot be reserved for another device).

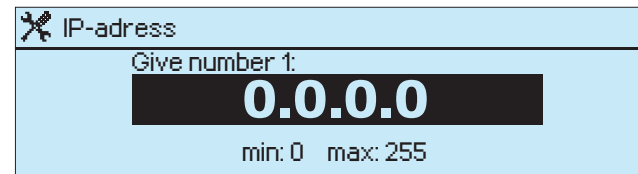
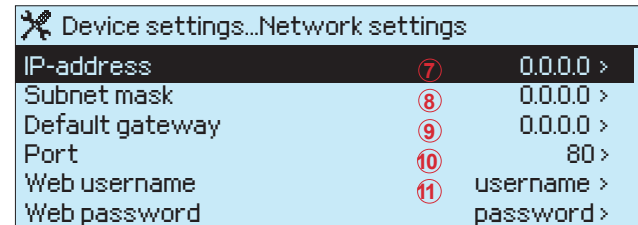

**Note!**  
Restart the controller after changing network settings for the changes to come into effect.

8. Enter the same subnet mask which you have written for yourself in item 4.
9. Enter the same gateway that you received into the controller.
10. The port address usually does not have to be changed. If port address 80 is reserved for some other device, change the port address (e.g., 81) and write the port number after the IP-address in the browser (e.g., http://10.2.40.50.81).

11. The factory setting for the WEB user name is name and the WEB password is password. Change the user name and password.

### Establishing a browser connection

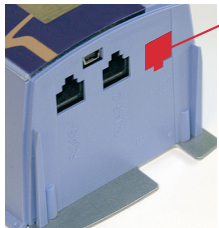

Connect the Ethernet cable to the connection on the EH-800 controller and restart the EH-800 controller. Write in the browser's address field the IP-address that has been entered into the controller, e.g., <http://10.2.74.146>. If no connection is made, check the address you have entered. Note! Do not write www in the beginning. Login to the browser using the WEB name that you have entered into the controller (it may take a moment to login).

### Instructions for connecting the EH-800 controller to the internet:

The EH-800 controller's network address must be known for it to be possible to use the public internet. This requires a separate name service.

Ouman remote control solutions (3G or Ouman ACCESS) make it easy to establish an internet connection. The EH-800 controller can be found with the name you have given it ( e.g., <http://avenue1.ouman.net>).

You must also make sure you have information security. **The controller should not be connected to the public Internet without using security service (firewall, protected connection).** In the Ouman 3G and Ouman ACCESS solution all information moving in the internet is shielded in both directions. Ouman 3G connections are made for building technology data transfer in which normal internet browsing is blocked.

Necessary information and settings that are needed daily appear on EH-800's basic display. In the event of an alarm, alarms also appear on the basic display.

You can check, e.g., measurements or settings in more detail by opening the pages at the top of the page.

# ✂ Display settings

Device settings -> Display settings

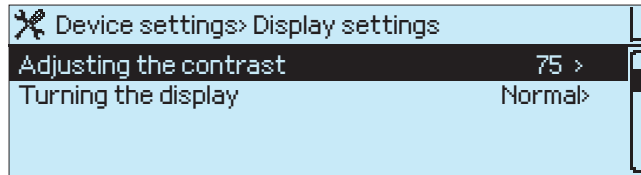

**Adjusting the contrast:** You can adjust the contrast. At 0 the display is bright and at 255 it is black. The change can be seen after you have confirmed the setting change.

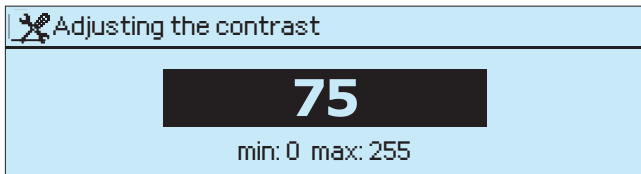

**Turning the display:** If the controller has to be installed upside down, the display can be turned so the text can be read right side up.

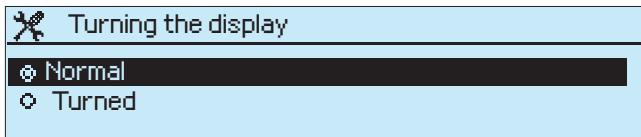

# ✂ Taking the locking code into use

Device settings -> Locking code

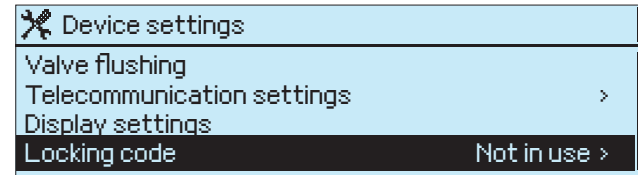

**If you take the locking code into use, you can read controller information when it is locked but you can't make changes to controller settings. It is good to take the locking code into use, for example, when the controller is in a place where anyone could change controller settings. Locking prevents unauthorized use of the controller.**

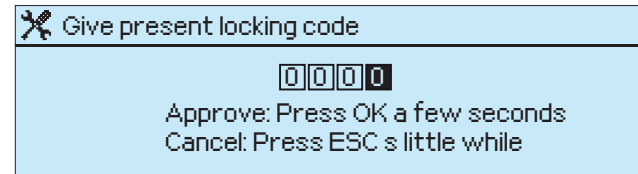

The controller asks for the present locking code. The locking code is 0000.

Turn the control knob and press OK to confirm the character.  
Press ESC to delete one character at a time.  
Press OK for a number of seconds to confirm.  
Press ESC for a number of seconds to delete the new code.

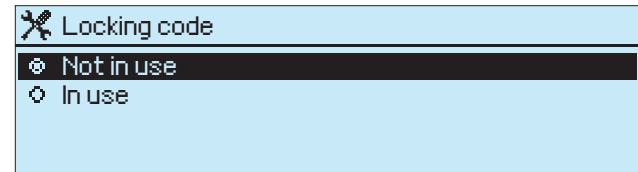

After you have entered the locking code (1324) you can take the locking code into use and then change it to a locking code of your choice.

# ✂ Change the locking code

Device settings -> Change the locking code

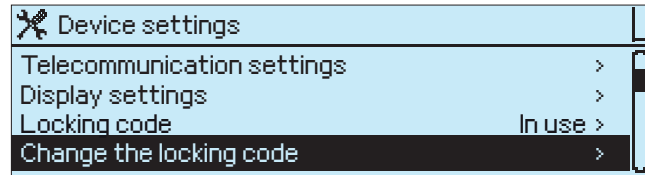

The factory set locking code is 0000.  
You can change the locking code.

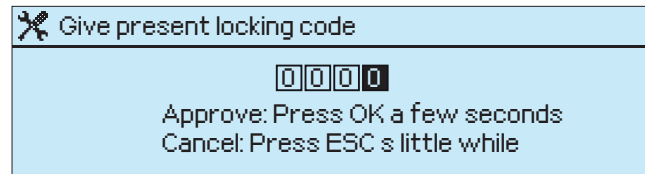

Write the new code on top of the old locking code.

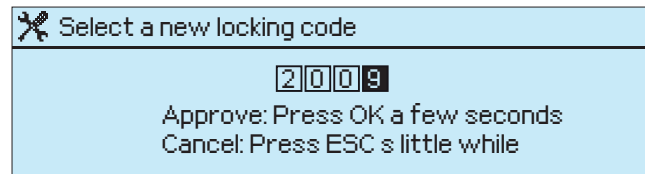

# ✂ Type information

Device settings -> Type information

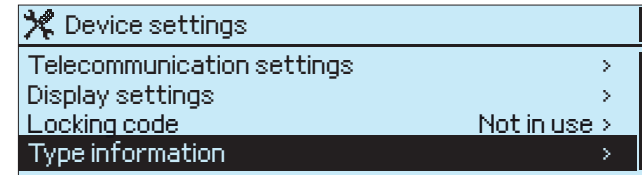

The type information tells you what controller is in question and what program version is in use and also the serial number. Write, e.g., the address of the controller in the location field of the controller. This is helpful when the controllers are connected to remote control and there are several locations to control.

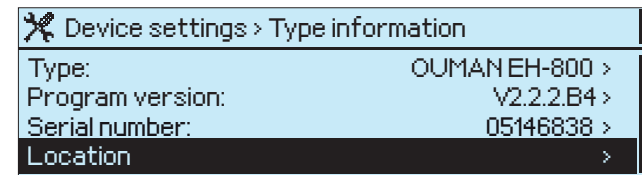

Write in the location field, e.g., the address of the device or a telephone number from which the owner or caretaker can be reached. You can use the information for remote administration, when you want to find the physical location of the controller sending an alarm.

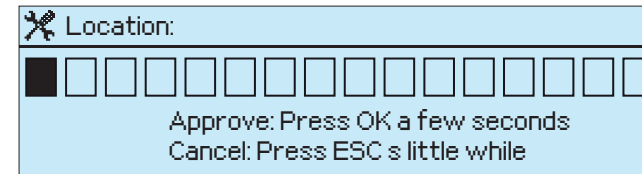

Naming a location:

Turn the control knob and press OK to confirm the letter or number.

Press ESC to return to the previous square.

Press OK for a number of seconds to confirm the name.

Key word:  
**Type information**



**Send a message: Type information.**

The controller will send the type information to your mobile phone. The message will give you the controller's program version, serial number and where the target is located.

# Communication via a mobile phone

It is possible to communicate with the controller via a GSM phone if a GSM modem has been connected to the controller. (optional equipment).

Communication occurs by using key words. Your mobile phone can receive information about the controller's measurements, active alarms, supply water or room temperature. You can also read and change the controller's settings or control mode or switch the controller to a temperature drop or nominal temperature.

Send the following text message to the controller: **KEY WORDS**.

You can send the text message question mark to the controller to get a list of key words. If the controller has a device ID in use (see p. 39), always write the device ID in front of the key word (example. TC01 KEY WORDS). **Capital and small letters are different characters in the device ID!**

The controller sends a list of key words as a text message that gives you information about the controllers' function. The key word is separated by a /. You can write the key word using capital or small letters. Write only one key word/message. Enter the key words into your phone's memory.

## Key words:

- Measurements
- H1 Settings
- H2 Settings
- H1 Room temperature info
- H2 Room temperature info
- H1 Supply water info
- H2 Supply water info
- H1 Control modes
- H2 Control modes
- Relay control
- Exception calendar
- Ouman
- Home
- Away
- Alarms
- Type information

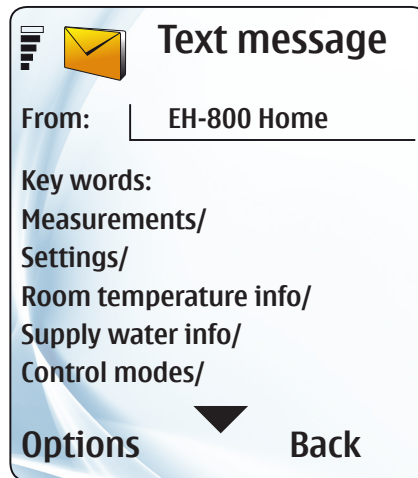

**Send the controller the message: ?  
The controller will send all the key words as a text message.**

## Informative messages:

- Measurements
- Room temperature info
- Supply water info
- Ouman
- Alarms
- Type information

These key words only give you information from the controller. **These messages cannot be changed and sent back to the computer!**

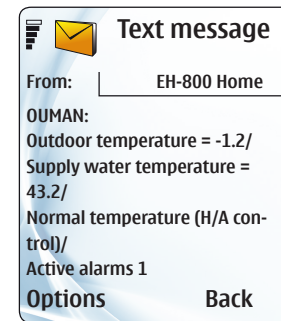

The Ouman key word gives you temperature measurement information (outdoor temp., supply water, room temp.). The message also includes the calculated supply water setting (=the controller determined supply water temperature from the supply water info). The message indicates the desired temperature (nominal temp., temp. drop, big temp. drop or pre-increase.) and indicates whether the control command has come from the week clock, exception calendar or Home/Away (H-A) control. If the controller is not on automatic, the message indicates whether the controller is on forced control, manual or stand-by. If the controller has an active alarm, the number of active alarms appears on the display.

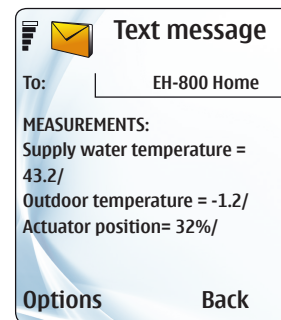

The key word Alarms gives you specific information about the alarms. The information is informative. You can't acknowledge alarms with this message.

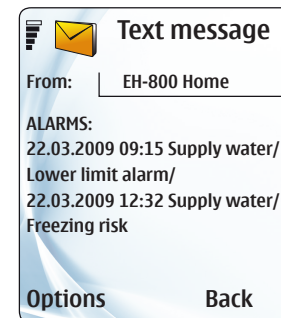

**If the controller has only one control circuit in use, you do not have to write H1 in front of the key word.**

# Communication via a mobile phone

**Key word:**

## Settings

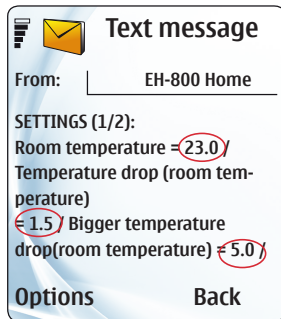

**Instructions for changing settings:**

Send the controller this message: Settings

The controller will send a return message with the main settings. If you want to change a setting, write the new setting in place of the old setting and send the changed message to the controller. The controller will make the changes and acknowledge by sending a text message with the new settings.

## Control modes

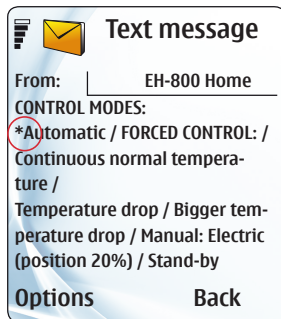

In the return message a star indicates the control mode that has been selected for the controller. If you want to change the control mode, move the star (\*) in front of the control mode that you want to take into use and send the message to the controller. Note! if you select "Manual", be especially careful because of the danger of freezing and overheating.

The key word relay control will give you a return message showing you the relay control mode. You can change the control mode by placing a star (\*) in front of the desired control (auto, ON or OFF).

**Exception calendar:** You can change the present exception calendar program, e.g., change the end time of the temperature drop by writing the new date in place of the old one and send the message to the controller. If an exception calendar program has not been made, the return message will have a form for the exception calendar. Write the date (dd.mm.yyyy) time (hh:mm) and mode that the controller switches to. The choices are "Bigger drop", "Drop", "Contin. nomin." or "Autom."

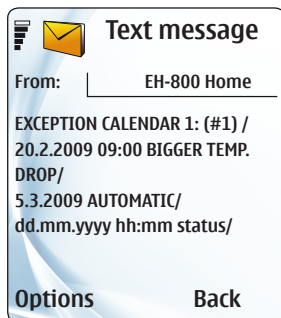

## Home

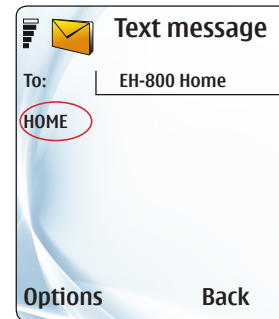

Use home control when a temperature drop has been made for the controller using the week/24 hour program or the exception calendar and you want to bypass the present temperature drop command. The home command switches the controller to a nominal temperature.

## Away

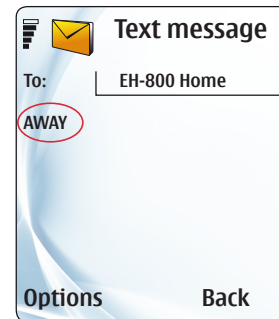

Use the away control command when you want to switch to a temperature drop. The controller maintains the temperature drop until it receives a "Home" control command. The control command can be given via a mobile phone, Home/Away switch or from the controller. If the controller has an exception calendar program in use and a "Home" control command has taken it from use, an "Away" control command will return the exception calendar back into use.

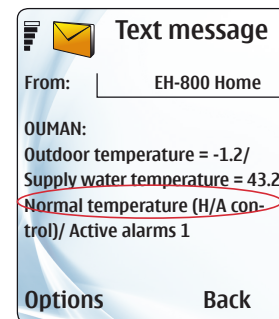

When either a "Home" or "Away" command is sent to the controller, the controller sends an informative OUMAN message as a return message. The message shows the temperature to which the Home/Away control (H-A) controls the controller.

When the concrete floor drying function is in use, the controller sends the same return message with any key word. The message shows the supply water temperature measurement information and the supply water settings which can be changed.



# Special settings

Basic menu -> H1 (H2)Settings -> Press OK for a number of seconds

Other settings for room control >

Here are more seldom needed settings which are hidden during normal use. Press OK for a number of seconds for them to appear and disappear in turn. The  symbol appears in front of special settings.

Setting	Factory setting:	Setting range:	Information about settings:
<b>Room temperature free temp. drop</b>	7°C	0...40°C	The lowest allowed room temperature during stand-by. If the room temperature measurement is not in use, the lower limit is given to the supply water temperature.
<b>Room temp measurement delay time</b>	2.0h	0.0...2.0h	The time period from which the average room temperature is calculated that room compensation uses.
<b>Room compensation ratio</b>		0.0...7.0°C	If room compensation differs from its set settings, the room compensation function adjusts the supply water temperature. For example, if the room compensation ratio is 4.0 and the room temperature has risen 1.5 °C above the setting, the controller drops the supply water temperature 6.0 °C (4 x 1.5 °C = 6 °C). If room compensation reacts too strongly to temperature changes, make the room compensation ratio smaller.
radiator network floor heating	4.0°C 1.5°C		
<b>Room compensation's max. effect</b>		5.0...95.0°C	Room compensation's maximum effect on the supply water Set maximum limits for room compensation here. If an external source of heat (e.g., a fireplace) effects room compensation so that rooms that are farther away get too cold, decrease the setting.
radiator network floor heating	15.0°C 6.0°C		
<b>Room compensation adjustment time</b>		0.0h...7.0h	The supply water temperature is adjusted during the room compensation adjustment time the "room temperature deviation x room compensation ratio" amount. A longer room compensation adjustment time is used in massive stone houses or houses with floor heating installed on a concrete floor.
radiator network floor heating	1.0h 2.5h		
<b>I control's max effect on supply wtr</b>		0.0...15.0°C	I-control's maximum effect on supply water I-control's maximum effect on the supply water is limited to the temperature set here. If the I-control causes continuous wavering of the room temperature, decrease the setting.
radiator network floor heating	6.0°C 2.0°C		

Setting	Factory setting	Setting range	Information about settings
---------	-----------------	---------------	----------------------------

**Other settings for room control >**

<b>Room temp. range, minimum value</b>	5.0°C	0.0...95.0°C	Limiting the lower limit for the room temperature range. Limiting the range can prevent an incorrect setting from being set.
<b>Room temp. range, maximum value</b>	50.0°C	0...95°C	Limiting the maximum limit for the room temperature range.

**Blocking a temperature drop during freezing temperatures:**

<b>Temperature drop blocked</b>	-45°C	0...-50°C	Temperature drops are blocked at this set outdoor temperature. The effect of the temperature drop function begins to be decreased 10 °C before this setting. The purpose of this function is to decrease the danger of water pipes freezing during extremely cold weather and to ensure that after a temperature drop period the temperature can rise to a normal level in a reasonable length of time. The setting is same for circuits H1 and H2.
---------------------------------	-------	-----------	---

**Supply water pre-increase:**

<b>Supply water pre-increase</b>		0.1...25.0°C	The amount, in degrees, of the automatic supply water pre-increase occurring at the end of the temperature drop (week clock or exception calendar). The pre-increase helps raise the room temperature more quickly back to a nominal room temperature after a temperature drop.
radiator network	4.0°C		
floor heating	1.5°C		
<b>Pre-increase time *)</b>	1h	1...10h	The pre-increase function raises the supply water temperature the pre-increase amount for the length of time determined here. The pre-increase begins to effect before the week clock /exception calendar controls to a nominal temperature.
<b>Pre-increase learning *)</b>	50%	0%...100%	The controller can use pre-increase learning to increase the above mentioned pre-increase time if the controller has not obtained a nominal temperature in the set pre-increase time. If, e.g., the pre-increase time has been set at 2 hours, and self- learning at 50%, the controller can, if necessary, either shorten or lengthen the pre-increase time by 50%, so that the pre-increase time can be 1-3 hours. The room temperature measurement must be in use for pre-increase self-learning to occur.

\*) shows only, if Supply water pre-increase is in use

**Minimum limits for the supply water temperature at different outdoor temperatures:**

<b>Supply water min limit at -20</b>		0...50°C	Supply water minimum limit with the outdoor temperature at -20. The minimum allowed supply water temperature when the outdoor temperature is -20 °C or below if it has been set higher than the "Supply water minimum limit" (see p. 12). This means that when the outdoor temperature is between 0 °C ...-20 °C the minimum allowed temperature for the supply water changes linearly between the supply water minimum limit setting and supply water minimum limit (outdoor t. -20 °C) setting.
radiator network	15°C		
floor heating norm.	23°C		
floor h. damp rooms			

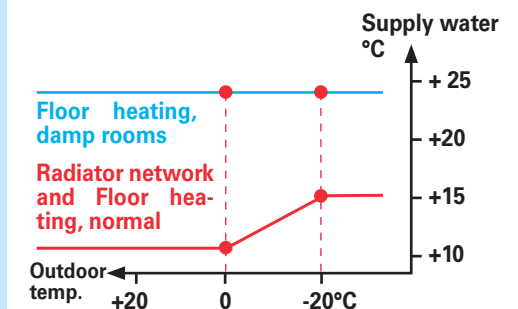





# Special settings

Basic menu -> H1 (H2) Settings -> Press OK for a number of seconds

Setting	Factory setting:	Setting range:	Information about settings:
<b>Supply water range, min value</b>	0.0°C	0.0...95.0°C	When the controller has been taken into use as a constant temperature controller, the supply water constant temperature range can be limited by giving the range a minimum limit.
<b>Supply water range, max value</b>	95.0°C	0.0...95.0°C	When the controller has been taken into use as a constant temperature controller, the supply water constant temperature range can be limited by giving the range a maximum limit.
<b>Fine adjustment</b>	0.0°C	-4.0...4.0°C	Press OK in the controller's main display to set the room temperature fine adjustment setting (see p. 5) The fine adjustment corrects the control when the room temperature is continuously too cold or too warm. When a room sensor is in use, the fine adjustment directly effects the calculated room temperature setting by + 4 °C. When a room sensor is not in use, the fine adjustment effects the curve as a parallel shift. The steepness of the curve does not change.
<b>Fine adjustment damping point</b>	7°C	0...17°C, -> not in use	<p>The user set outdoor temperature limit at which the effect of fine adjustment begins to decrease. The effect of fine adjustment has completely disappeared with the outdoor temperature at +20 °C. This prevents, e.g., unnecessary heating in the when the weather is hot. As a factory setting the damping point is 7 °C. The fine adjustment setting is not in use when the outdoor temperature setting is above 17 °C (the function is not in use if the room temperature measurement is connected).</p>
<b>Calibration of the fine adjustment</b>	1.0	0.5....2.0	If fine adjustment does not change the room temperature as desired, the fine adjustment can be calibrated. Use the following form for calibration: "desired change"/"actual change." For example, if you want to raise the room temperature 2 °C but it has only risen 1 °C, set the calibration at 2.0 (2/1). If it has risen 3 °C, set the calibration at 0.7 (=2/3). The function is in use if the room temperature sensor has not been connected.

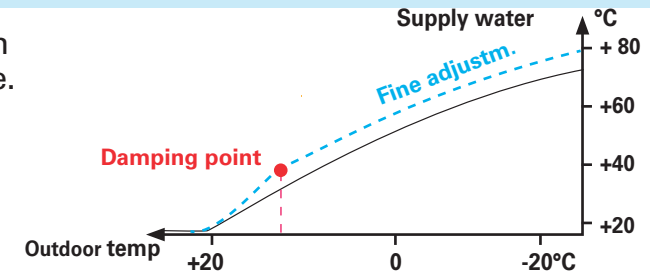

Setting	Factory setting:	Setting range:	Information about settings:
<b>Stand-by settings:</b> <b>Supply water free temp. drop. at 0</b>	10 °C	0...50 °C	In the stand-by function, the lower limit of the supply water's free temperature drop at an outdoor temperature of 0 °C and above.
<b>Supp. water free temp. drop. at -20</b> radiator heating floor heating	15 °C 20 °C	0...50 °C	In the stand-by function, the lower limit of the supply water's free temperature drop at an outdoor temperature of -20 °C or below. The stand-by function's lowest allowed supply water temperature with outdoor temperatures between 0 °C...-20 °C changes linearly between the above mentioned settings.
<p><b>Return water control settings (measurement channel 4 has been taken into use for return water measurement)</b></p>			
<b>Return water minimum limit</b>	7 °C	5..95 °C	The minimum return water temperature with the outdoor temperature above 0 °C.
<b>Return wat. min limit outd temp -20</b>	10 °C	5..95 °C	The minimum return water temperature with the outdoor temperature at -20 °C or below. With outdoor temperatures between 0 °C...-20 °C, the freezing protection limit changes linearly between the above mentioned settings. The controller gives a freezing risk alarm if the supply water temperature drops below the supply water minimum limit setting.
<b>Return water maximum limit</b>	95 °C	5...95 °C	As a factory setting the return water temperature measurement is used as an informative measurement. If you want other uses for the return water measurement, you can change the highest allowed return water temperature. The controller begins lowering the supply water temperature after the maximum limit has been exceeded.
<b>Return water compensation</b>	2.0	0.0...4.0 °C	The return water compensation changes the supply water temp. when the return water exceeds the return water max. limit or falls below the return water minimum limit. The supply water temp. change = " return water compensation ratio" x "the amount of degrees that the return water temp. exceeds the maximum limit / falls below the lower limit". For example, if the comp. ration for the return water 2.0, and the temp. of the return water exceeds the max. limit by 1.5°C, the return water temp. is lowered 3.0°C (2 x 1.5 °C = 3.0 °C).
<p><b>Taking heating control into use after a summer function:</b></p>			
<b>Summer function's max clearance delay</b>	10 h	0...20 h	The purpose of the summer function's clearance delay is to delay heating so that in the summer the heat does not go on during the night when the temperature drops close to zero degrees for short periods of time. The clearance delay is the active summer function time x 1.7, but is limited to the maximum clearance delay that is set here. The clearance delay is inactivated in the following instances: If the room sensor is in use and the room temperature drops at least 0,5° C below the setting, in the event of a power failure.
<b>Valve position at summer function</b>	Controlling	Controlling Closed	You can either set the temperature of the supply water in the H2 control circuit at its minimum limit or you keep control activated in the H2 control circuit during summer function.

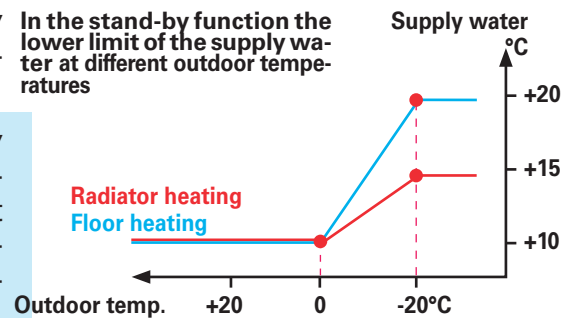



# Special settings

Basic menu -> H1 (H2) Settings -> Press OK for a number of seconds

Setting	Factory setting:	Setting range:	Information about settings:
<b>Autumn drying function and settings:</b>			
<b>Autumn drying</b>			
Room temperatur	1.0°C	...0.1...5.0°C	The amount the room temperature is raised when autumn drying is in use. (room sensor required).
Supply water			
- radiator heating	3.0°C	...0.1...15.0°C	The amount the supply water temperature is raised when autumn drying is in use.
- floor heating	1.2°C	...0.1...7.0°C	

**Autumn drying outdoor temp limit** 7°C 0...15°C

Autumn drying is activated when the average temperature in a 24-hour period has continually been above the "autumn drying outdoor temperature limit" (factory setting 7 °C) for a period of at least 20 days and after this drops below this limit. Autumn drying is activated during the next 20 days whenever the average temperature in a 24-hour period is under the autumn drying temperature limit. The setting is same for circuits H1 and H2.

*In autumn, the temperature of the supply water is automatically raised for a certain period of time through autumn drying. This decreases dampness in structures and takes away the damp feeling that you often get after summer.*

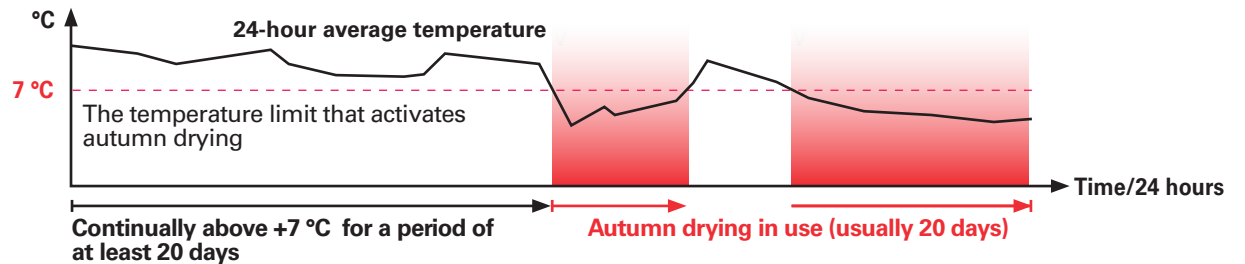

## Tuning supply water setting

<b>P-area</b>	250°C	2...600°C	The supply water temperature change at which the actuator runs the valve at 100%. For example, if the temperature changes 10 °C and the P-area is 200 °C, the position of the actuator changes 5%.
<b>I-time</b>	50s	5...300s	The deviation in the supply water temperature from the set value is corrected by P amount in I-time. For example, if the deviation is 10 °C, the P-area is 200 °C and the I-time is 50 s, the actuator is run at 5% for 50 seconds. Beware of constant waver!
<b>Valve clearance</b>	0.0 %	0.0...15.0	The ball valves of heating control systems may have some clearance. This possible clearance may cause some jitter which can be eliminated by increasing the valve clearance value in the controller. You should first try for example the value 3% and check if this solves jitter problem. The control can be optimized by trying different values. Note! Too high value can also cause jitter. This feature is available only in the control loop H1.

**Supply w. max. speed of change** 4.0°C/min 0.0...5.0

The maximum speed at which the supply water can be raised when switching from a temperature drop to a nominal temperature. If the radiators knock, slow down the rate of change (set the setting smaller).

# Product packages

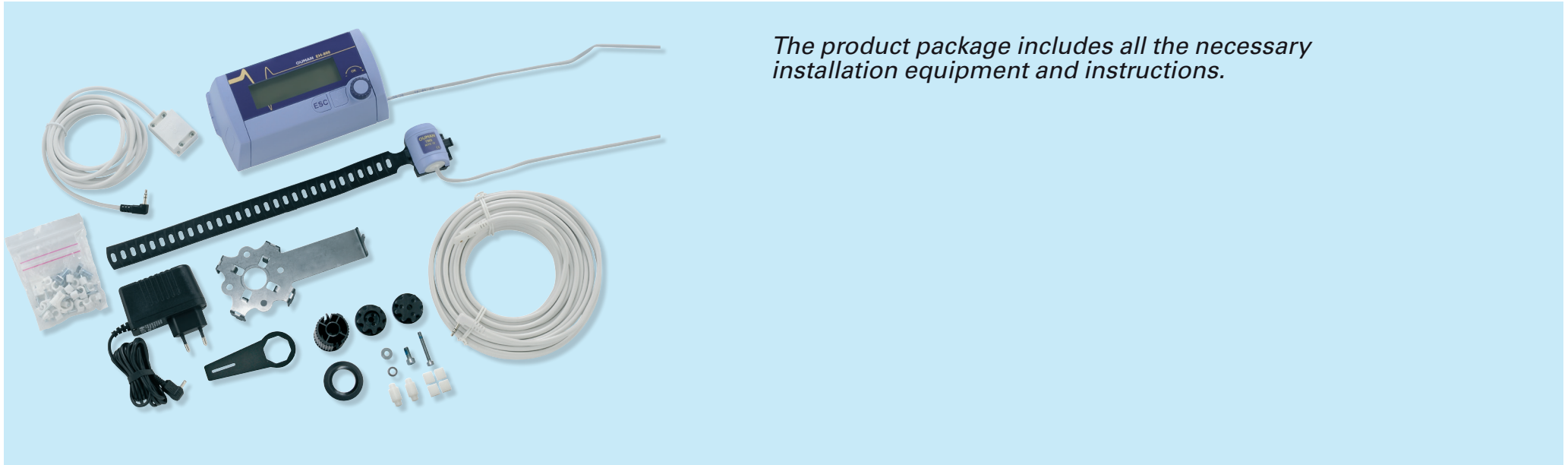

*The product package includes all the necessary installation equipment and instructions.*



*EXP-800 product package content: Pre-connected expansion unit, connecting cable, Belimo HTC24-SR -valve engine, adapter for the most common mixing valve, TMS-3M -surface temperature sensor and the introduction of the necessary instructions.*

# Other optional equipment

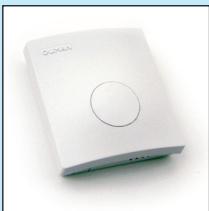

## TMR, Room sensor

Electr. no (in Finland): 71 655 44 (TMR/NTC10)  
Position the room sensor (TMR) so that it measures the facility's average temperature. Connect the sensor to the controller as a two-wire connection using weak current cable and connecting cord.



## EXU-800, Extension unit

An extension unit (connect using the RJ45) that makes it possible to take a second heating control circuit into use and control, e.g., a pump summer stop using a relay. It also makes it possible to receive alarm information from, e.g., a spark detector or heating network pressure switch.



## TMR/SP, potentiometer having a room temperature measurement

Using the TMR/SP, the set room temperature can be dropped 5 °C or raised 4 °C without changing the controller setting. Connect the sensor to the controller as a three-wire connection using weak current cable and connecting cord.



## GSMMOD5, GSM modem

The GSM modem makes it possible to communicate with the EH-800 controller via GSM. The modem can be connected directly to the controller or via the extension unit. When the extension unit is in use the power source for the modem can be taken from the extension unit.

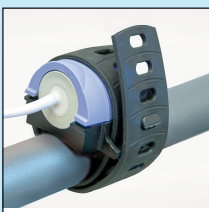

## TMS, surface sensor

Can be obtained without a connecting cable or with either a 2, 3 or 4 meter connecting cable. Can be adapted to both supply water and return water temperature measurements



## ANT1, External antenna

An external antenna for the Ouman GSM/GPRS modem

- Antenna with a small magnet base
- 2,5 m antenna cable, FME connection



## Home/Away switch

surface or flush mounting

- Surface mounting, electr. no. 71 655 48
- Flush mounting, electr. no. 71 655 50



## CE-GSM10 Antenna extension cord

An external antenna for the Ouman GSM/GPRS modem

- 10 m antenna cable, FME connection
- Extension piece
- Used with the ANT1 external antenna



## Surface thermostat C01A

In houses with floor heating it is important to ensure that excessively hot water that could damage structures or surfaces does not enter the heating system. C01A is a thermostat that stops the circulation pump in the event of overheating.



## ACCESS security solution

Ouman Access is an affordable, safety and intelligent remote access to automation equipment. It uses an existing internet connection, which means you can use it immediately. Access package includes an Access-device, RJ-45 cable and power supply.



## Wireless 3G package for the EH-800 model

3G-MOD3 is a wireless connection to Access -devices or for their verification. You can buy the subscription from your preferred operator.

# What to do if there is a fault

## The room temperature becomes too cold

Check the main display to see the controller's control mode and temperature. Check if the controller has already completely opened the valve, if the temperature measurement information is correct and are there active alarms.

1. Check the supply water info to see what factors are effecting the controller determined supply water setting and change the settings if necessary (see p. 9-10).
2. If the supply water info indicates that the supply water temperature deviates from the calculated supply water temperature, check whether the valve is stuck. Completely depress the manual control knob and turn the manual control lever at the same time. Make sure that the controller has been positioned on the valve so that the valve can open completely. (see p. 29) The valve must be able to move freely (90°). At the same time, check that the valve direction is correct. If the valve is stiff, ask an HVAC installer to clean the valve axle and hole going through the cover and change the seals.
3. If the valve is completely open and it's not warm enough, check if the temperature of the boiler or accumulator is higher than the supply water temperature. If the temperature of the boiler or accumulator is the same as the supply water temperature, find out why the boiler or accumulator does not warm up.
4. The controller gives a sensor fault alarm if the controller is not able to read temperature measurement information. Contact Ouman Oy maintenance.
5. Check the pressure of the heating network using a pressure meter. If the pressure in the network drops frequently, contact an HVAC installer.
6. Check whether the circulation pump is running. If the pump doesn't run as it should, contact an HVAC installer.

## The room temperature becomes too hot

Check the controller's main display to see if the controller has already completely closed the valve, is the temperature measurement information correct or are there active alarms.

1. If the valve is not completely closed, check the supply water info to see what factors are effecting the controller determined supply water setting and change the settings if necessary (see p. 9-10).
2. Make sure that the valve is not stuck. Make sure that the controller has been positioned on the valve so that the valve can open completely. (additional information on p. 29) Make sure the valve direction is correct.
3. The controller gives a sensor fault alarm if the controller is not able to read temperature measurement information. Contact Ouman Oy maintenance.

### If the device has a fault:

Close the valve using electrical manual operation. Disconnect the cords and take the device off of the valve. Do not take off the manual controller lever. Send the device to Ouman Oy. Include your name, address, telephone number and a description of the fault.

### Warranty:

Ouman Oy has given EH-800 a three year warranty for the device. The warranty covers repair of the device at an Ouman Oy factory and includes necessary spare parts. The warranty is not in effect if the device has been installed incorrectly or mechanically damaged. The warranty does not cover indirect or consequential loss or damages. It does not cover the cost connected with finding a fault, detaching the device, or sending or installing the device.

### Disposing of the EH-800 controller:



The enclosed marking on the additional material of the product indicates that this product must not be disposed of together with household waste at the end of its life span. The product must be processed separately from other waste to prevent damage caused by uncontrolled waste disposal to the environment and the health of fellow human beings.

The users must contact the retailer responsible for having sold the product, the supplier or a local environmental authority, who will provide additional information on safe recycling opportunities of the product. This product must not be disposed of together with other commercial waste.

# Index

---

- 3G-connection, 40-41, 53
- 3 point/5 point curve 6, 30, 35
- Access 41-42, 52
- Accumulator temperature 25, 22, 32, 33, 37
- Active alarms 21, 23
- Actuator calibration 38
- Air-to-water heat pump control 17, 32, 37
- Alarm history 23
- Alarm information relayed to a mobile phone 23, 40
- Alarm limits 22
- Alarms 21-23, 17, 37
- Alarm that can be freely labelled 22, 24
- Automatic control 14
- Autumn drying 51
- Big temperature drop 12, 14, 19-20
- Burner alarm 25
- Communication via mobile phone 39-40, 45-46
- Concrete floor drying during construction 28
- Connecting cable 26
- Constant temperature controller 28
- Control modes 14, 2
- Curve settings 6, 27, 30, 35
- Deviation alarm 22
- Device ID 39
- Device settings 23-44
- Display settings 43
- Emptying alarm history 23
- EXP-800 and EXU-800 32, 33, 35, 39, 52
- Extension unit 52
- Fine adjustment 49, 5
- Floor heating 2, 27
- Forced drive 14, 15, 20, 2
- General alarm 17, 37
- GSM function 39-40, 45-46
- GSM modem 39
- Heating mode selection 27-28, 35
- Hidden settings 47-51
- Home/away control 15, 46
- Home/Away switch 25, 52
- Internet 41-42
- I-time 47, 51
- Key words 45
- Labelling the control circuit 31-35
- Language selection 23
- Locking code 43-44
- Locking settings 43-44
- Manual mechanically 14
- Meas. that can be freely labelled 25
- Measurement settings 24-26
- Measurements 7-8
- Message centre number 39
- Ouman key word 45
- Outdoor temperature 2, 7
- Outdoor temperature 's 24-hour average 7
- Outdoor temperature delay function 7, 13
- Outdoor temperature sensor 54
- P-area 51
- PIN 39
- Pre-increase function 48
- Pressure alarm 25
- Process settings 27-33
- Pump alarm 25
- Pump interval use 16
- Pump summer stop 34, 16, 13
- Quick guide for temperature control 5-6 and separate instructions
- Radiator heating 2, 27, 35, 56
- Relay control 33, 36-37, 16-18
- Relay week program 18
- Return water compensation 50
- Return water min. and maximum limit 50
- Return water temperature 7, 25
- Return water temp. alarm limits 21, 50
- Room compensation 47
- Room temp. potentiometer (TMR/P) 25
- Room I-control 47
- Room potentiometer 25, 52
- Room temperature 11, 12, 24
- Room temperature alarm limits 22
- Room temperature drop 12, 14, 15, 19, 20
- Room temperature maximum setting 50
- Room temperature minimum setting 50
- Selection of curve type 30, 35
- Selection of valve direction 29
- Sensor connection 26
- Setting the date 21
- Setting the time 21
- Solar collector 25, 33, 35
- Spark alarm 26, 52
- Special calendar 20
- Stand-by 14, 47
- Summer function 13, 16, 36, 50
- Summer stop 13, 16, 36, 50
- Supply water info 9-10
- Supply water min and maximum limit 6,13
- Supply water range's max limit/value 49
- Supply water range's min limit/value 49
- Supply water sensor 33, 52
- Supply water setting's speed of change 51
- Supply water temperature's alarm limits 22
- Swimming pool temperature control 28
- Technical information 57
- Telecommunication settings 39-40
- Temperature drop 12, 14-15, 19-20
- Temperature drop block 48
- Temperature drop week program 19
- Time program 18-20
- Too cold 5-6 and quick guide
- Too hot 5-6 and quick guide
- Trend display 8
- Tuning the supply water setting 51
- Type information 44
- Valve control information 2, 57
- Valve direction 29
- Valve flushing 38
- Valve position 2, 7, 14, 17, 37, 38
- Week program 19, 18
- What to do if there is a fault 53

# Technical information

**Controller:** Compact PI controller. The controller and actuator in one. The actuator's torque is 10 Nm and the swing angle is 90° and speed 150 s.

**Control modes:** Outdoor compensated supply water control  
Outdoor and room compensated control  
Supply water constant temperature control  
Drying use (concrete floor drying)

**Operating voltage:** 24 VDC, 3.5W (cord and plug-in power source is included)  
(the operating voltage can also be 24 VAC, 50/60 Hz, 7 VA)

**Casing:** PC/ ABS, IP 42

**Mounting:** Can be mounted to Termomix and Esbe 3MG valves using the mounting kit included  
Mounting kits for Esbe VRG and Belimo R4..D(K) valves as optional equipment

**Dimensions (mm):** width 172, height 91, depth 73

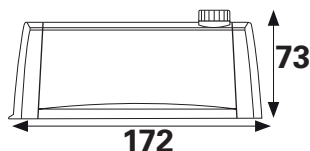

**Weight:** 900g

**Operating temperature:** 0...50°C (storing -20...+70°C)

**Approvals:**  
**EMC-directive** 2014/30/EU, 93/68/EEC  
**-Interference tolerance** EN 61000-6-1  
**-Interference emissions** EN 61000-6-3  
**Small voltage directive** 2014/35/EEC, 93/68/EEC  
**-Safety** EN 60730-1

## CONNECTIONS:

**Supply water sensor:** Pre-connected NTC surface sensor, 1.5 m fixed connection cord, time constant < 2s

**Outdoor temperature sensor:** 15 m cord with plug, if necessary it can be lengthened or shortened, NTC, time constant < 10 min

**Measurement 3 and 4: taken into use using a connection cord)** Use: e.g., room compensation (measurement and/or potentiometer), home/away switch, alarm contact use, return water temperature measurement, etc.

**USB-device:** PC's connection, e.g., in program updating

**RJ45-2:** RS-232 connection for GSM-modem  
**Connection occurs using the extension unit** (optional equipment)  
1 pc Universal input  
1 pc Digital input  
1 pc Digital output  
1 pc Analog output

**Ethernet :** Local network / internet connection (not in the EH-800B model)

**RJ45-1:** Battery backup (connection occurs using the extension unit, not in the EH-800B model)

**Warranty:** 3 years

**Manufacturer:** Ouman Oy  
[www.ouman.fi](http://www.ouman.fi)

